



You're safer with us

# Our Products

English  
Edition 20





# Zero lives lost in collisions with commercial vehicles and mobile machinery

**It's a big challenge but we are on a mission to deliver this vision.**

Brigade is at the pinnacle of commercial vehicle and mobile plant blind-spot safety. A founder and innovator of sensing and monitoring systems that have helped save lives for over forty years.

Whilst our portfolio may be emulated, our commitment to vehicle safety, our reliable, trusted products and our dedicated team of experts, cannot. We invest in people as well as technology. Everyone in the Brigade family understands the life-changing significance of the products and service we provide and the importance of outstanding systems that work in the most demanding of situations.

For the future: We will continue to inform and work with policy makers and industries to ensure blind-spot mitigation is effective. We will recruit the highest calibre people who are passionate about what we do. We will impart expert knowledge and advice to help customers with their challenges. We will always seek to innovate and bring new products to market that help prevent collisions and save lives. We will strive to achieve our vision of zero lives lost by constantly improving the safe operation of commercial vehicles and mobile plant around the world.

- Brigade Electronics Group Plc management systems are certified to ISO9001:2015
- Our principal manufacturing facilities are certified to IATS16949:2016
- All applicable products have CE-marking in Europe and FCC/IC approval in North America
- The majority of our products comply with UN ECE Regulation 10 (EMC)
- Combinations of our camera monitor systems are certified to Regulation 46
- Cables are UNECE R118 compliant
- Our products comply with REACH and RoHS





# Contents

<b>Compliance kits</b>	<b>6</b>
<b>Mirror-replacement systems</b>	<b>8</b>
<b>Backeye®360</b>	<b>11</b>
<b>Backeye® Camera Monitor Systems</b>	<b>15</b>
R46 for Indirect Vision	16
Camera Monitor Compatibility	17
Elite Range Monitors	18
Elite Range Cameras	20
Elite Range Cables	22
Elite Range Kits	24
Select Range High Definition Monitors	25
Select Range High Definition Cameras	26
Select Range High Definition Cables	28
Select Range High Definition Kits	29
Select Range Monitors	30
Select Range Cameras	32
Select Range Cables	35
Select Range Kits	38
Essential Range Kits	41
Adapter Cables	42
Ancillaries	44
<b>Mobile Digital Recording</b>	<b>47</b>
Bridge 4G Hosted Service	48
Recorders	49
IP Cameras	52
<b>Ultrasonic Object Detection</b>	<b>55</b>
<b>Backsense® Radar Object Detection</b>	<b>63</b>
<b>Reversing and Warning Alarms</b>	<b>69</b>
bbs-tek® White Sound Alarms	70
Quiet Vehicle Sounder	71
Speaking Alarms	72
<b>ZoneSafe® RFID Tag Detection Systems</b>	<b>75</b>
<b>Warranties</b>	<b>79</b>
<b>Index by Model number</b>	<b>80</b>
<b>Index by Part number</b>	<b>82</b>
<b>Glossary</b>	<b>84</b>

# Compliance kits

## Are you compliant?

Legislation, regulation and certification heavily influences the automotive industry at all levels.

We aim to provide high quality safety solutions that surpass requirements, because that is the best way to keep drivers and vulnerable road users safe.

For further information, please visit the **Regulations and Legislation** section at [brigade-electronics.com](http://brigade-electronics.com)

**Model**

**Part No:**

### FLEET OPERATOR RECOGNITION SCHEME (UK)



The Fleet Operator Recognition Scheme (FORS) is a voluntary accreditation scheme in the UK for fleet operators which aims to raise the level of quality within the transport business, and demonstrate which operators are achieving exemplary levels of best practice in safety, efficiency and environmental protection.

For further information about FORS compliance, visit [brigade-electronics.com/FORS](http://brigade-electronics.com/FORS)

### FORS SILVER COMPLIANCE KIT

**FORS-SS-01 - FORS Silver for rigid vehicles**

**6077**



1. VBV-770-000 - Select 7" monitor / rear camera system	4692
2. VBV-300C - Select side view camera, flush-mount eyeball camera - mirror view PAL	5211
3. VBV-L405 - Select 5m camera cable	1499
4. SS-4100W - Sidescan® Side sensor system with mute function	5257
5. LS-60-A - Low speed trigger module	4851
6. TS-001ECU - Turn Indicator Trigger ECU	1362
7. SS-BC-08 - Left side-turn external warning alarm - 90dB	1334
8. TCO-47(01) - Latched Side-turn Alarm Cut-Out	4752
9. Blind spot take care vehicle sticker	LIT0402

A reversing alarm is also required for FORS Silver compliance. If not already fitted, please see our full range of bbs-tek® White Sound® alarms.

Dependent on vehicle and application, additional components may be required. If in doubt, please contact us.



## DIRECT VISION STANDARD (Safe System)

The Direct Vision Standard (DVS) is the first legislation of its kind. From 26th October 2020, ALL goods vehicles over 12 tonnes will require a HGV safety permit to drive into Greater London, including vehicles from outside of the UK.

For comprehensive information about the DVS, visit [brigade-electronics.com/DVS](http://brigade-electronics.com/DVS)

### DVS COMPLIANCE KIT

**DVS-SS-01 - Direct Vision Standard for rigid vehicles**
**6076**

1. VBV-770M - Select 7" digital LCD monitor	4288
2. VBV-300C - Select side view camera, flush-mount eyeball camera - mirror view PAL	5211
3. VBV-L405 - Select 5m camera cable	1499
4. SS-4100W - Sidescan® Side sensor system with mute function	5257
5. LS-60-A - Low speed trigger module	4851
6. TS-001ECU - Turn Indicator Trigger ECU	1362
7. SS-BC-08 - Left side-turn external warning alarm - 90dB	1334
8. TCO-47(01) - Latched Side-turn Alarm Cut-Out	4752
9. Blind spot take care vehicle sticker	LIT0402

### DVS COMPLIANCE KIT

**DVS-CS-01 - Direct Vision Standard for articulated vehicles**
**6078**

1. VBV-770M - Select 7" digital LCD monitor	4288
2. VBV-300C - Select side view camera, flush-mount eyeball camera - mirror view PAL	5211
3. VBV-L405 - Select 5m camera cable	1499
4. CS-3100 - Cornerscan® Side sensor system with mute function	5261
5. LS-60-A - Low speed trigger module	4851
6. TS-001ECU - Turn Indicator Trigger ECU	1362
7. SS-BC-08 - Left side-turn external warning alarm - 90dB	1334
8. TCO-47(01) - Latched Side-turn Alarm Cut-Out	4752
9. Blind spot take care vehicle sticker	LIT0402

# Backeye®eMirrors

## Mirror replacement system

In association with



**For a driver, being able to see blind spots around the vehicle is a necessity. Using a camera monitor system for visibility instead of mirrors can offer many benefits.**

Replace conventional Class II and Class IV mirrors with high-definition externally mounted side-view cameras and a pair of high definition (HD) monitors typically mounted on the A-frame inside the cab. Installation is best carried out at or by a vehicle manufacturer or bodybuilder as must be homologated, ensuring compliance with Regulation 46 (devices for indirect vision). Unique to each vehicle model which requires homologation by an approved test house in order to comply with the R46 and ISO specifications for indirect vision

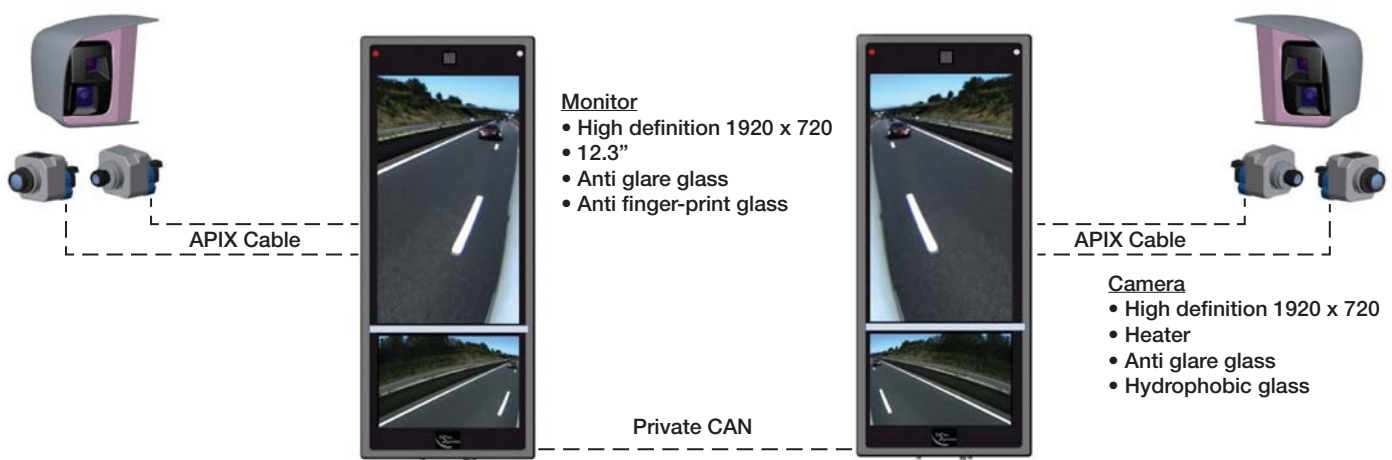

### Monitor features:

- High Definition (HD)
- Screen layout can be configured to replicate the replaced mirror positions
- Built-in light sensor for automatic screen brightness
- Monitors are linked via a private CAN network for auto-screen balance/ brightness and system operating data
- Anti glare and fingerprint glass ensures the image is always clear
- Distance markers

### Camera features:

- High Definition (HD)
- Two cameras per side/housing (Class II and Class IV or Class V)
- Cameras mounted in housing, behind heated, anti-glare, hydrophobic treated glass
- Optional integrated lens cleaning with pressurised air or water.



### Certification:

- UN ECE Regulation No 46 (R46), regarding devices for indirect vision and their installation. Only camera monitor systems with R46 approval may be installed in place of a compulsory mirror..
- ISO 16505
- ISO 26262





## Why install a camera monitor system in place of mirrors?

- **Wider viewing angle**

A camera has a wide viewing angle which allows the driver to see more than the minimum required Field of View. A driver does not need to physically move to view a broader area as would be necessary with a conventional mirror.

- **No damage to mirrors and improved aerodynamics**

Because of their size and the distance they protrude, mirrors are prone to being hit and broken. A smaller, flush-mounted camera reduces the risk of damage, lowering maintenance costs and vehicle downtime. Replacing mirrors with cameras also improves aerodynamics which contributes to lower fuel consumption.

- **No glare and reduced light reflection**

Low sun and headlights can be dazzling for drivers, creating glare and making it difficult or impossible to define objects in mirrors. A camera system automatically adjusts to the lighting, significantly reducing glare and therefore improving driver visibility by displaying a clear image on the monitor.

- **Better visibility at night**

Night time visibility is one of the key advantages a camera system has over a conventional mirror. Low-light (low lux) capability and auto-image enhancement mean greatly improved visibility in low light conditions and a clear image on the monitor, even in almost total darkness.

- **Better visibility in the rain**

Mirrors are challenging to use in the rain. Not only does the driver need to see the vehicle and surroundings in the mirror, but through an equally wet and sometimes misted window. Water and dirt obscure the view, hugely reducing driver visibility. The camera aperture will focus through water on the lens, maintaining visibility in any type of environment or weather condition. A heated camera also helps to keep the lens free from moisture.

For more information, please contact us on +44(0) 1322 420300 or [sales@brigade-electronics.com](mailto:sales@brigade-electronics.com)



# Backeye®360

## 360° Camera Monitor System

### How it works

Backeye@360 is an intelligent camera monitor system designed to assist low-speed manoeuvring by providing the driver with a complete 'bird's-eye' surround view of the vehicle in real time.

360° technology works with four ultra wide-angle cameras, each covering one full side of the vehicle with a viewing angle of over 180°.

High-mounted on the front, rear and sides, the calibrated cameras capture all of the surrounding area including the blind spots of the vehicle or machine.

The four live images are simultaneously sent to an electronic control unit (ECU) where they are instantly

processed, combined, blended and stitched. The distortion from the wide-angle camera lens is also corrected so that a clear, real-time view of all around the vehicle is provided to the driver in a single image on the monitor.

Backeye@360 will work on most vehicles and machines, large or small. Our expert team of Applications Engineers can advise on installation to everything from a van to a 200 tonne dump truck, including rigid and articulated trucks and buses, loading shovels, excavators, lift trucks, straddle carriers and many others.

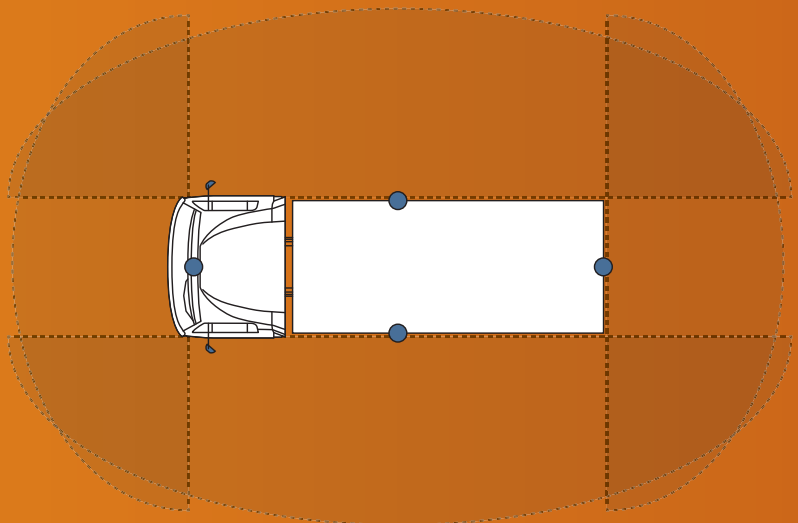

Model

Part No:

**NEW**

## AHD 360° CAMERA SYSTEM

**HD**

**BN360-300 - High Definition Backeye®360 system**

**5800**



- IP69K cameras
- 12-24Vdc
- Size (WxHxD) ECU  
178 x 113 x 26mm
- Size (WxHxD) Camera  
61 x 50 42mm
- 5 year warranty

**AHD**

### Contents

- 1 x ECU
- 4 x BN360-1000C cameras
- 1 x Video output cable to connect to SELECT range monitor.
- 1 x set-up/view-select button
- 1 x ECU power harness
- 1 x ECU interface/video input harness

### Features

- 720p HD 360° image
- 15 different view modes (10 x landscape & 5 x portrait configurations)
  - Front & rear crossing-traffic
  - Customisable vehicle position
- 2 pre-defined configuration groups
- Configure & customise set up via PC calibration software
- Left, right, reverse & speed signal triggers
- Configurable on-screen parking markers
- Customisable overlay guidelines per camera view
- 2 x video outputs
- Ultra-wide viewing angle cameras (HxV) 182° x 118°
- 1/4" CMOS sensor
- Video output: AHD 1.0 and NTSC

### Power

- Power consumption: 15 Watts
- Current: 1.22 Amps

### Durability & Standards

- Mechanical vibration: 8.5G
- Mechanical shock: 51G
- Operating temperature: -30 to +75°C
- IP30 ECU
- CE marked
- E-Marked: UNECE R10 compliant
- FCC Approved
- IC Approved
- ISO 20653:2006
- ISO 13766-1:2018

### NOTES:

- Calibration kit is required for installation.
- Monitor and camera extension cables not included
- Individual cameras not recordable on MDR - monitor output only.

**NEW**

## BN360-300 CABLES

**HD**

BN360-H320	HD 20m camera cable	5809
BN360-H315	HD 15m camera cable	5810
BN360-H310	HD 10m camera cable	5811
BN360-H305	HD 5m camera cable	5812
BN360-H3025	HD 2.5m camera cable	5813

**NEW**

## BN360-300 360° CAMERA MONITOR SYSTEMS

**HD**

**Complete 360 AHD camera monitor system for large rigid vehicles**

**SE-770H-300 - 360 AHD camera system with VBV-770HM - 7" AHD monitor**

**6114**



- 1 x VBV-770HM AHD Monitor
- 1 x BN360-300 AHD 360 system
- 1 x BN360-H310 - 10m camera cable
- 2 x BN360-H315 - 15m camera cables
- 1 x BN360-H320 - 20m camera cable

See individual products for detailed specifications and warranties

## BN360-200/BN360-300 MOUNTING BRACKETS



BN360-100C-BKT01	Adaptable mounting bracket Can be shaped to allow installation on non-vertical surfaces	4649
BN360-100C-BKT02	Mounting bracket to adjust camera angle	4714
BE360-CD	Deflector to shield camera from knocks (To be used with BN360-100C-BKT02 Mounting bracket)	4701
BN360-100C-BKT03	Deflector to shield camera from knocks	4743

**Model**

**Part No:**

**360° CAMERA SYSTEM**

**BN360-200 - Backeye®360 system**

**5200**



- IP69K cameras
- 12-24Vdc
- Size (WxHxD) ECU  
174 x 101 x 30mm
- Size (WxHxD) Camera  
61 x 46 x 36mm
- 5 year warranty

**MDR** COMPATIBLE **R46** APPROVED\*

**Contents**

- 1 x ECU
- 4 x BN360-100C cameras
- 1 x Video output cable to connect to SELECT range monitor.
- 1 x set-up/view-select button
- IR receiver & remote control
- 1 x ECU power harness
- 1 x ECU interface harness

**Features**

- 360° image
- 19 different view modes (max 10 views per chosen configuration group) including:
  - Landscape or portrait configurations
  - Front & rear crossing-traffic
  - Left & right lane changing assist
  - Customisable vehicle position
- 4 pre-defined configuration groups
- Configure & customise set up via monitor and IR remote control
- Left, right, reverse & speed signal triggers
- Configurable on-screen parking markers
- 3 x video outputs
- Ultra-wide viewing angle cameras (HxV) 185° x142°
- 1/3.7" CMOS sensor
- TV system: NTSC or PAL via switch on ECU (cameras NTSC only)

**Power**

- Power consumption: 8 Watts
- Current: 0.65 Amps

**Durability & Standards**

- Mechanical vibration: 8.5G
- Mechanical shock: 51G
- Operating temperature: -30 to +75°C
- IP30 ECU
- CE marked
- E-Marked: UNECE R10 compliant
- FCC Approved
- IC Approved
- ISO 20653:2006
- ISO 13766:2006
- EN 13309:2010
- \*Camera monitor system R46 approved

**NOTES:**

- **calibration kit is required for installation.**
- **Monitor and camera extension cables not included**

**BN360-200 CABLES AND ADAPTERS**



BN360-L120	20m camera cable	4493
BN360-L115	15m camera cable	4495
BN360-L110	10m camera cable	4496
BN360-L105	5m camera cable	4498
BN360-L1025	2.5m camera cable	4499
AC-305	Splitter cable for MDR (1 required per camera)	4903

**BN360-200 REQUIREMENTS FOR ARTICULATED VEHICLES**



BN360-Enclosure	IP66 Enclosure kit to enable ECU to be installed on outside of vehicle	4723
SK-15-05	Articulated vehicle cable kit for BN360-200 (3-camera)	5066

**BN360-200 360° CAMERA MONITOR SYSTEMS**

Complete 360 camera monitor system for large rigid vehicles



SE-7104F-100	360 camera system with VBV-7104FM - 10.4" monitor	5378
SE-770-100	360 camera system with VBV-770M - 7" monitor	5379



- 1 x Monitor
- 1 x BN360-200 360 system
- 1 x BN360-L110 - 10m camera cable
- 2 x BN360-L115 - 15m camera cables
- 1 x BN360-L120 - 20m camera cable

See individual products for detailed specifications and warranties



# Backeye<sup>®</sup> Camera Monitor Systems

## A Winning Range

Camera monitor systems are used in a wide range of on and off-road applications to meet a host of health and safety and legislative requirements.

Brigade's camera monitor systems enable drivers and operators to manoeuvre and drive safely. Vehicle-mounted cameras can help the driver to see blind spots by delivering a live feed on the monitor of everything in the camera view, including people or obstacles.

Whether you need an entry-level reversing camera or full-vehicle camera system, we can help. With single-to-multiple camera inputs and auto-triggers, Brigade cameras and monitors will work on any application in any industry.

Brigade's camera monitor systems are compatible with its range of Mobile Digital Recorders (MDR).

### ELITE

Top of the range systems that are the first choice for Original Equipment Manufacturers (OEMs) and Bodybuilders. Exceptional quality and consistent performance in the harshest conditions. Rigorously tested to higher standards, the superior components and build quality are reflected in the Elite series' 5 year warranty. Ideal for heavy duty applications including N2 and N3 Heavy Goods Vehicles (HGVs), on/off-highway vehicles, agricultural machinery and mobile plant used on Construction, Civil Engineering, Quarry and Mine sites.

### SELECT

High quality, reliable, best-selling mid-range systems. First choice in the Aftermarket and popular also with OEMs and Bodybuilders. 3 year warranty. Ideal for medium to large on-highway vehicles and smaller off-highway mobile plant.

### ESSENTIAL

Entry level reversing solution for cost-conscious Aftermarket customers. Ideally suited for on-highway applications.

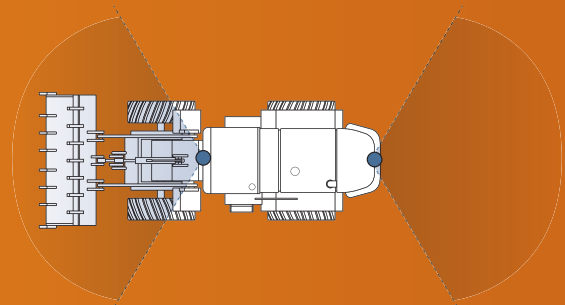
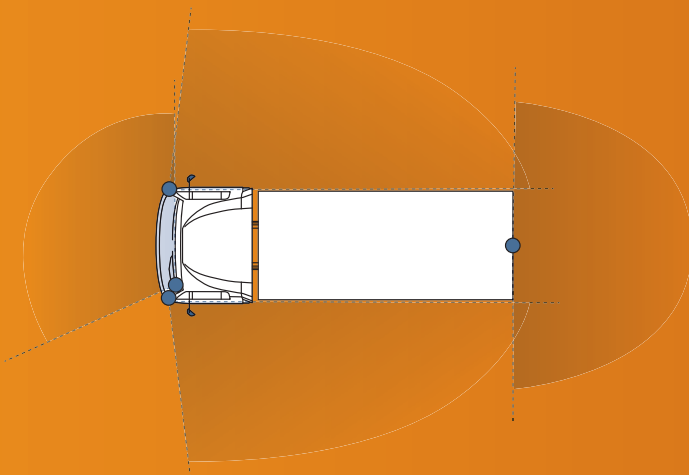

# R46 for Indirect Vision

## R46 for Indirect Vision

UNECE Regulation No 46 (R46) is a regulation which covers devices for indirect vision and their installation.

R46 is widely recognised as a mark of exceptional performance, reliability and quality. In order to comply with the R46 regulation, the components of a camera monitor system must reach specified performance standards and be installed within pre-defined guidelines.

The following Brigade camera/monitor combinations are approved to UNECE Regulation No 46 for areas Class V and Class VI. If correctly installed, an R46 approved camera monitor system can replace a conventional mirror.

See [brigade-electronics.com/R46](http://brigade-electronics.com/R46) for further information.

Camera/monitor combinations approved to R46			MONITORS		
			ELITE	SELECT	
			BE-870LM	VBV-770M	VBV-7104FM
<b>CAMERAS</b>	<b>ELITE</b>	BE-800C BE-890C BE-850C	✓ plus full and split screen using SS-002 screen splitter	✗	✗
	<b>SELECT</b>	VBV-300C VBV-320C	✓ plus full and split screen using SS-002 screen splitter	✓ plus full and split screen using SS-002 screen splitter	Single, split and quad screen ✓
		VBV-700C VBV-790C	✗	✓ plus full and split screen using SS-002 screen splitter	Single, split and quad screen ✓
	<b>360</b>	BN360-200	✗	Full screen and standard split screen ✓	Standard 360 view in both landscape and portrait on single, split and quad screens. Full 360 view in portrait on single, split and quad screens. ✓

European Directives 2003/97/EC and 2007/38/EC (Class areas V and VI) for vehicles over 3.5 tonnes to be retrofitted with devices in order to improve the driver's field of vision and increase vehicle safety.

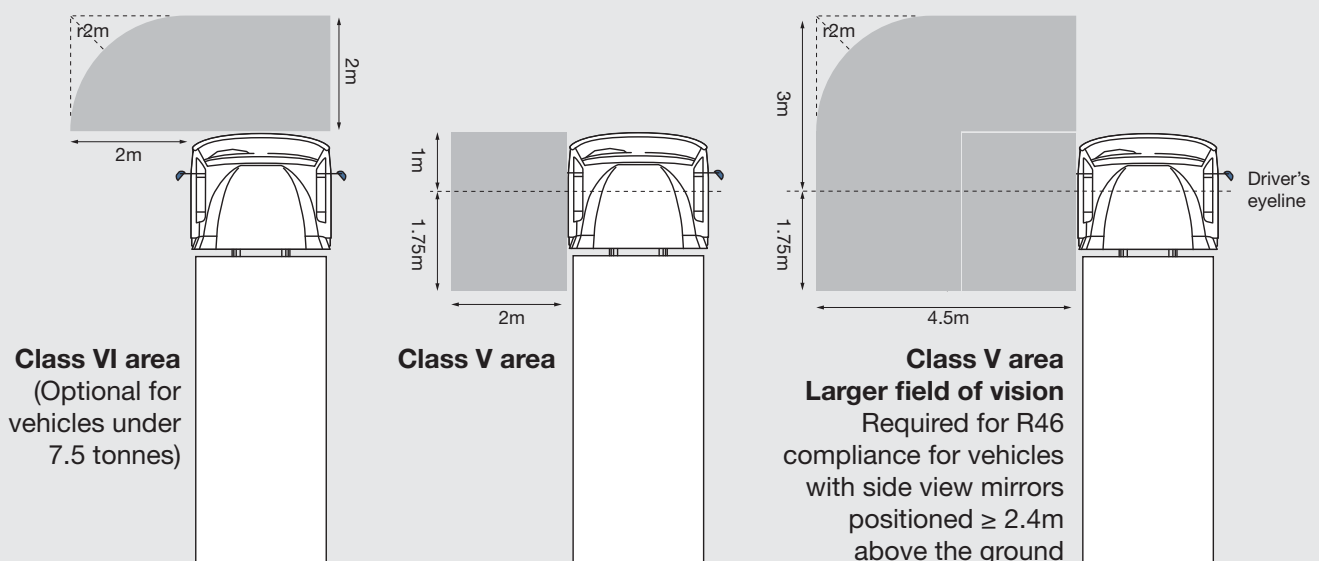



# Camera/monitor compatibility

			MONITORS			
			ELITE		SELECT	
			BE-970WFM BE-970WM BE-865DDM BE-870LM BE-870FM	BE-856GM	VBV-7104FM VBV-770FM VBV-770M VBV-750M	VBV-770M-S VBV-750M-S
<b>CAMERAS</b>	<b>ELITE</b>	BE-810C Shutter	✓	✓ SC-1000-ECU	✓ AC-007 & SC-1000-ECU	✗
		All other Elite cameras	✓	✓	✓ AC-007	✓ AC-007
	<b>SELECT</b>	VBV-710C Shutter	✓ AC-035 & AC-006	✓ AC-035 & AC-006	✓ AC-035	✓
		All other Select cameras	✓ AC-006	✓ AC-006	✓	✓

### Camera icons



Infrared LEDs for ultra-low-light performance



Day/night sensor



Audio



Heater



Normal/mirror view

**WDR**

Wide Dynamic Range

**DWDR**

Digital Wide Dynamic Range

### Monitor icons



Number of camera inputs



Number of auto-triggers



Audio



'Button-lock' anti-tamper feature



On-screen distance and vertical line markers



Normal/mirror view - switching from menu

### Cable icons

(Black = solid/pins)



Male connector Select



Female connector Select



Male screw fit connector Elite



Female screw fit connector Elite



Male push fit connector Elite



Female push fit connector Elite



Male shutter connector Select



Female shutter connector Select



Male Backeye@360 connector



Female Backeye@360 connector

Model

Part No:

## 7" IP69K MONITOR

ELITE



BE-970WM - Waterproof 7" Digital LCD monitor

3351



- 12-24Vdc
- IP69K
- Size (WxHxD)  
194 x 124 x 48mm
- 5 year warranty



### Features

- 2 Camera inputs
- Shutter camera compatible - both inputs
- Backlit touch screen button panel
- 'Button-lock' anti-tamper feature
- 2 Auto-triggers
- Mirror / Normal switching from menu
- On screen distance and vertical line markers
- Audio
- Sun shield
- Multi-lingual menus
- Auto-switching PAL / NTSC

### Picture Quality

- LED backlighting (gives 20,000 hours life)
- Anti-glare screen
- Resolution: 800 x 480
- Contrast ratio: 500:1
- Brightness: 500cd/m<sup>2</sup>
- Viewing angles:  
Side 65° x Top 50° x Bottom 60°

### Power

- Power consumption: 11 Watts
- Current: 0.9 Amps

### Durability & Standards

- Aluminium die-cast casing
- Mechanical vibration: 20G
- Mechanical shock: 100G
- Operating temperature: -40 to +70°C
- CE marked
- E-Marked: UNECE R10 compliant
- ISO 16750
- ISO 13766: 2006
- HALT tested

## 7" IP69K QUAD MONITOR

ELITE



BE-970WFM - Waterproof 7" Quad digital LCD monitor

3560



- 12-24Vdc
- IP69K
- Size (WxHxD)  
194 x 124 x 48mm
- 5 year warranty



Plus additional in-built image options

### Features

- 4 camera inputs
- Shutter camera compatible (inputs 1&2)
- Backlit touch screen button panel
- 'Button-lock' anti-tamper feature
- 5 Auto-triggers
- Mirror / Normal switching from menu
- On screen distance and vertical line markers
- Audio
- Speed switch trigger to turn monitor on/off or trigger a split screen
- Sun shield
- Multi-lingual menus
- Auto-switching PAL / NTSC

### Picture Quality

- LED backlighting (gives 20,000 hours life)
- Anti-glare screen
- Resolution: 800 x 480
- Contrast ratio: 500:1
- Brightness: 500cd/m<sup>2</sup>
- Viewing angles:  
Side 65° x Top 50° x Bottom 60°

### Power

- Power consumption: min 28 Watts
- Current: max 2.15 Amps

### Durability & Standards

- Aluminium die-cast casing
- Mechanical vibration: 10G
- Mechanical shock: 100G
- Operating temperature: -40 to +75°C
- CE marked
- E-Marked: UNECE R10 compliant
- ISO 16750
- ISO 20653: 2006
- HALT tested

**Model**

**Part No:**

**7" QUAD MONITOR**

**ELITE**

**BE-870FM - 7" Digital LCD monitor**

**2146**



- 12-24Vdc
- Size (WxHxD)  
197 x 135 x 30mm
- 5 year warranty

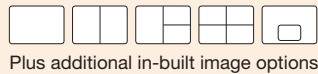

Plus additional in-built image options

**Features**

- 4 camera inputs
- 5 Auto-triggers
- Shutter camera compatible
- 'Button-lock' anti-tamper feature
- Mirror / Normal switching from menu
- On-screen distance & vertical line markers
- Audio
- Sun shield
- Auto-dimmer
- Multi-lingual menus
- Auto-switching PAL / NTSC

**Picture Quality**

- LED backlighting (gives 20,000 hours life)
- Anti-glare screen
- Resolution: 800 x 480
- Contrast ratio: 500:1
- Brightness: 4000cd/m<sup>2</sup>
- Viewing angles:  
Side 70° x Top 50° x Bottom 70°

**Power**

- Power consumption: 21 Watts
- Current: 1.9 Amps

**Durability & Standards**

- Mechanical vibration: 6G
- Mechanical shock: 100G
- Operating temperature: -40 to +70°C
- CE marked
- E-Marked: UNECE R10 compliant
- HALT tested

**7" MONITOR**

**ELITE**

**BE-870LM - 7" Digital LCD monitor**

**2705**



- 12-24Vdc
- Size (WxHxD)  
197 x 128 x 34mm
- 5 year warranty



**Features**

- 2 Camera inputs
- Shutter camera compatible - both inputs
- 'Button-lock' anti tamper feature
- 2 Auto-triggers with configurable trigger-off delays
- Mirror / Normal switching from menu
- On-screen distance and vertical line markers
- Audio
- Sun shield
- Auto-dimmer and keypad illumination
- Multi-lingual menus
- Auto-switching PAL / NTSC

**Picture Quality**

- LED backlighting (gives 20,000 hours life)

- Anti-glare screen
- Resolution: 800 x 480
- Contrast ratio: 500:1
- Brightness: 400cd/m<sup>2</sup>
- Viewing angles:  
Side 70° x Top 50° x Bottom 70°

**Power**

- Power consumption: 12 Watts
- Current: 1 Amp

**Durability & Standards**

- Mechanical vibration: 2.5G
- Mechanical shock: 51G
- Operating temperature: -30 to +70°C
- CE marked
- E-Marked: UNECE R10 compliant
- \*Camera monitor system R46 approved

**5.6" MONITOR**

**ELITE**

**BE-856GM - 5.6" Digital LCD monitor**

**3756**



- 12-24Vdc
- Size (WxHxD)  
172 x 115 x 32mm
- 5 year warranty



**Features**

- 2 camera inputs
- 2 Auto-triggers
- Mirror / Normal switching from menu
- On-screen distance & vertical line markers
- Audio
- Sun shield
- Auto-dimmer
- Multi-lingual menus
- Auto-switching PAL / NTSC

**Picture Quality**

- LED backlighting (gives 20,000 hours life)
- Anti-glare screen
- Resolution: 640 x 480

- Contrast ratio: 500:1
- Brightness: 350cd/m<sup>2</sup>
- Viewing angles:  
Side 70° x Top 50° x Bottom 70°

**Power**

- Power consumption: 11 Watts
- Current: 0.9 Amps

**Durability & Standards**

- Mechanical vibration: 10G
- Mechanical shock: 50G
- Operating temperature: -40 to +70°C
- CE marked
- E-Marked: UNECE R10 compliant
- ISO 13766: 2006
- ISO 16750
- HALT tested

## What is WDR?

Wide Dynamic Range (WDR) automatically balances lighting in a camera image for improved detail in highlights and shadows.

This is particularly useful when working in environments where lighting quickly changes, for example; reversing into a dark loading bay on a sunny day. The transition from bright light to shadow will cause cameras that do not feature WDR to fail to pick up fine details. Areas of the picture will be bright and other areas extremely dark.

WDR Cameras balance lighting so no areas are under or over exposed, improving clarity and detail in the image.



Standard camera



WDR camera



### Model

### Part No:

#### CAMERA WITH DWDR

#### ELITE



<b>BE-900C - Integrated fisheye correction - PAL</b>	<b>5277</b>
<b>BE-990C - Integrated fisheye correction - PAL - No audio</b>	<b>5279</b>
<b>BE-901C - Integrated fisheye correction - NTSC</b>	<b>5278</b>
<b>BE-991C - Integrated fisheye correction - NTSC - No audio</b>	<b>5280</b>

- Viewing angle (HxVxD)  
96 X 64 X 110° PAL  
100 X 65 X 106° NTSC
- IP69K/IP68
- Size (WxHxD)  
86 x 72 x 80mm
- 5 year warranty



#### DWDR

#### Features

- Integrated image correction for wide viewing angle (fisheye) lens distortion
- Digital Wide Dynamic Range for improved detail in shadows and highlights
- 5 Infrared LEDs for ultra-low light performance
- Day / Night sensor
- Heater
- Microphone (BE-900C & BE-901C)
- Mirror / Normal view
- Automatic white balance
- Sony CMOS sensor
- TV lines: PAL: 400 NTSC: 350

#### Power

- Power consumption: 4.5 Watts
- Current: 0.36 Amps

#### Durability & Standards

- Mechanical vibration: 8.5G
- Mechanical shock: 51G
- Operating temperature: -40 to +70°C
- CE marked
- E-Marked: UNECE R10 compliant
- FCC Approved
- ISO 20653:2006
- ISO 16750-4

#### SHUTTER CAMERA WITH WDR

#### ELITE



<b>BE-810C - Shutter camera</b>	<b>1242</b>
---------------------------------	-------------

- Viewing angle (HxVxD)  
103 x 71 x 134°
- IP68 / IP69K
- Size (WxHxD)  
123 x 86 x 80mm
- 5 year warranty

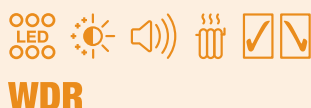

#### WDR

#### Features

- Wide Dynamic Range for improved detail in shadows and highlights
- 5 Infrared LEDs for ultra-low light performance
- Day / Night sensor
- Automatic shutter
- Heater
- Microphone
- Mirror / Normal view
- Backlight compensation
- Automatic white balance
- Sony CMOS sensor
- TV System: PAL
- TV Lines: 450

#### Power

- Power consumption: 5.4 Watts
- Current: 0.45 Amps

#### Durability & Standards

- Mechanical vibration: 8.5G
- Mechanical shock: 51G
- Operating temperature: -40 to +70°C
- CE Marked
- E-Marked: UNECE R10 compliant
- FCC approved
- IC approved
- ISO 13766-1:2018

**Model**

**Part No:**

**CAMERA WITH WDR**

**ELITE**



BE-800C	- PAL	1623
BE-801C	- NTSC	1905
BE-800C(40)	- Narrow viewing angle: 32 x 24 x 41° PAL	1559
BE-801C(40)	- Narrow viewing angle: 33 x 25 x 42° NTSC	2085
BE-800C(78)	- Narrow viewing angle: 69 x 51 x 92° PAL	1426
BE-801C(78)	- Narrow viewing angle: 71 x 52 x 94° NTSC	2084
BE-890C	- Waterproof to IP69K, No microphone, PAL	2871
BE-891C	- Waterproof to IP69K, No microphone, NTSC	5426
BE-850C	- 12/24Vdc, waterproof to IP69K, PAL	4924
BE-800C-NIR	- No LEDs, PAL	4247

• Viewing angle (HxVxD)  
 102 x 76 x 132° PAL  
 108 x 80 x 136° NTSC

• IP68

• Size (WxHxD)  
 86 x 72 x 80mm

• 5 year warranty



**R46 WDR**  
APPROVED\*

**Features**

- Wide Dynamic Range for improved detail in shadows and highlights
- 5 Infrared LEDs for ultra-low light performance (except BE-800C-NIR)
- Day / Night sensor
- Heater
- Microphone
- Mirror / Normal view
- Automatic white balance
- Sony CMOS sensor
- TV lines: 600

**Power**

- Power consumption: 4.5 Watts
- Current: 0.33 Amps (0.37 - 2.63 Amps BE-850C)

**Durability & Standards**

- Mechanical vibration: 8.5G
- Mechanical shock: 51G
- Operating temperature: -40 to +85°C
- CE marked
- E-Marked: UNECE R10 compliant
- FCC Approved
- IC Approved
- ISO 13766:2006
- ISO 20653:2006
- EN13309:2010
- \*Camera monitor system R46 approved BE-800C, BE-890C & BE-850C only

**MINI CAMERA**

**ELITE**



BE-820C	- Mini camera (mirror image) PAL	1927
BE-821C	- Mini camera (mirror image) NTSC	2002
BE-822C	- Mini camera (normal image) PAL	2151
BE-823C	- Mini camera (normal image) NTSC	5100

• Viewing angle (HxVxD)  
 115 x 92 x 140° PAL  
 113 x 90 x 136° NTSC

• IP68

• Size (WxHxD)  
 47 x 40 x 50mm

• 5 year warranty

**Features**

- Backlight compensation
- Automatic white balance
- 1/4" Sony CCD
- TV System: PAL or NTSC
- TV Lines: 600

**Power**

- Power consumption: 0.9 Watts
- Current: 0.1 Amps

**Durability & Standards**

- Mechanical vibration: 10G
- Mechanical shock: 100G
- Operating temperature: -40 to +80°C
- CE marked
- E-Marked: UNECE R10 compliant
- FCC approved (NTSC models only)
- IC approved (NTSC models only)
- HALT tested
- ISO 20653:2006

Model

Part No:

## CAMERA TO MONITOR CABLES

ELITE



BE-L130	- 30 metre cable	0800
BE-L120	- 20 metre cable	0801
BE-L115	- 15 metre cable	0802
BE-L112	- 12 metre cable	3008
BE-L110	- 10 metre cable	0803
BE-L108	- 8 metre cable	3007
BE-L105	- 5 metre cable	0804
BE-L101	- 1 metre cable	5042
BE-L1003	- 0.3 metre cable	2797

## ELITE CAMERA EXTENSION CABLES

ELITE



BE-X025	- 25 metre extension cable	1907
BE-X020	- 20 metre extension cable	1143
BE-X015	- 15 metre extension cable	2101
BE-X010	- 10 metre extension cable	2100
BE-X005	- 5 metre extension cable	2099
BE-X003	- 3 metre extension cable	0805

## TRUCK/TRAILER CABLE KIT

ELITE



<b>SK-31E - Truck and trailer cable kit - unique pin layout</b>	1830
<small>Inclusive of SK-31E-T - Trailer kit</small>	

• BE-L110 - 10m cable for cab	0803
• SP-7A - 7-pin bulkhead socket for cab & cab-end camera connector (unique pin layout)	1827
• SC-7 - Coiled cable with 7-pin plugs (unique pin layout)	1829

<b>SK-31E-T - Trailer only kit</b>	1886
• BE-X020 - 20m extension cable for trailer	1143
• SP-7B - 7-pin bulkhead socket for trailer & trailer-end camera connector (unique pin layout)	1828

## TRUCK/TRAILER CABLE KIT

ELITE



<b>SK-30E - Truck and trailer cable kit</b>	1144
<small>Inclusive of SK-30E-T - Trailer kit</small>	

• BE-L110 - 10m cable for cab	0803
• SP-07C - 7-pin bulkhead socket for cab & cab-end camera connector	1140
• SC-07 - Coiled cable with 7-pin plugs	1046

<b>SK-30E-T - Trailer only kit</b>	1885
• BE-X020 - 20m extension cable for trailer	1143
• SP-07T - 7-pin bulkhead socket for trailer & trailer-end camera connector	1142

Model

Part No:

**TRUCK/TRAILER CABLE KIT**

**ELITE**



**SK-15-01 - Truck and trailer cable kit for three cameras**

**3427**

• SP-15A-01 - 15-pin bulkhead socket for cab & 3 cab-end camera connectors

3423

• SP-15B-01 - 15-pin bulkhead socket for trailer & 3 trailer-end camera connectors

3422

• SC-15-01 - Coiled shielded cable with 15-pin plugs

3268



SP-15A-01

SC-15-01

SP-15B-01

**TRUCK/TRAILER CABLE KIT**

**ELITE**

**SK-15-04 - Truck and trailer cable kit for single camera & single buzzer ultrasonic detection system**

**3997**



• SP-15A-04 - 15-pin bulkhead socket for cab & cab-end camera connector plus stripped wires and display/buzzer connection for Ultrasonics

3955

• SP-15B-04 - 15-pin bulkhead socket for trailer & trailer-end camera connector plus stripped wires and display/buzzer connection for Ultrasonics

3956

• SC-15-01 - Coiled shielded cable with 15-pin plugs

3268



SP-15A-04

SC-15-01

SP-15B-04

**TRUCK/DRAWBAR TRAILER CABLE KIT**

**ELITE**

**SK-50E - Truck and drawbar trailer cable kit for two cameras - unique pin layout**

**1570**

Inclusive of SK-50E-A Truck kit and SK-31E-T trailer kit



**SK-50E-A - Truck only kit**

**1879**

**SK-31E-T - Trailer only kit**

**1886**

• BE-L115 - 15m cable for truck

0802

• BE-X005 - 5m extension cable for truck camera

2099

• CS-020 - Two way camera selector

1571

• SP-7A - 7-pin bulkhead socket for trailer & trailer-end camera connector (unique pin layout)

1827

• SC-7 - Coiled cable with 7-pin plugs (unique pin layout)

1829

• BE-X020 - 20m extension cable for trailer camera

1143

• SP-7B - 7-pin bulkhead socket for cab & cab-end camera connector (unique pin layout)

1828



SP-7A

SC-7

SP-7B

Model

Part No:

## CAMERA MONITOR SYSTEMS

ELITE

BE-870L-000 - Single camera monitor system for rigid vehicles

3231



- BE-870LM - 7" monitor 2705
- BE-800C Camera 1623
- BE-L120 - 20m cable 0801

See individual products for detailed specifications and warranties

**R46**  
APPROVED

BE-870L-100 - Single shutter camera monitor system for rigid vehicles

4032



- BE-870LM - 7" monitor 2705
- BE-810C Shutter camera 1242
- BE-L120 - 20m cable 0801

See individual products for detailed specifications and warranties

BE-856G-000 - Single camera monitor system for rigid vehicles

4012



- BE-856GM - 5.6" monitor 3756
- BE-800C Camera 1623
- BE-L120 - 20m cable 0801

See individual products for detailed specifications and warranties

## OPTIONAL EXTRA

Add VBV-300C (low mount) or VBV-320C (high mount) side view camera + BE-L105 (5m cable) + AC-006 Adapter to spot cyclists.





## What is AHD?

An Analogue High Definition (AHD) camera monitor system is an analogue system that supports High Definition video resolutions. The resolution of HD & AHD systems is measured in pixels per square inch (p). AHD 1.0 supports 720p HD resolution and AHD 2.0 supports 1080p HD resolution.

### What about PAL and NTSC formats?

HD cameras operating at 25Hz (25frames per second) are compatible with PAL format (so we call them PAL). HD cameras operating at 30Hz (30 frames per second) are compatible with NTSC format (so we call them NTSC).

### What should I consider when choosing between AHD and traditional CVBS systems?

There are many factors to consider when choosing between AHD and traditional CVBS, including compatibility with other systems and bandwidth/memory capacity if connecting to a mobile digital recorder. (AHD systems will use more bandwidth for transmission and will take up more memory for the same time period). For the best HD quality results, all parts of the system should be AHD.



AHD camera image



Traditional CVBS camera image

### Compatibility with existing traditional CVBS systems:

- Brigade HD cables can be used instead of traditional CVBS cables for all Brigade SELECT camera monitor systems.
- Brigade HD cameras can be used with our MDR-500 series Mobile Digital Recorders (MDR),
- Brigade's traditional CVBS cameras can be used with our new HD monitors (camera image will not be HD).
- Brigade's traditional CVBS monitors are not compatible with HD cameras.

**Model**

**Part No:**

**NEW AHD 7" MONITOR**

**SELECT**

**VBV-770HM - 7" High Definition LCD monitor**

**5611**



- 12-24Vdc
- Size (WxHxD)  
196 x 118 x 26mm
- 3 year warranty



#### Features

- AHD and CVBS compatible
- High-definition, high contrast, wide view angle
- 3 camera inputs
- 3 Auto-triggers
- Mirror / Normal switching from menu
- 'Button lock' anti-tamper feature
- On-screen distance markers
- Audio
- Sun shield
- Auto-dimmer
- Multi-lingual menus
- Auto-switching AHD 1.0 / AHD 2.0 / PAL / NTSC

#### Picture Quality

- LED backlighting (gives 20,000 hours life)

- Anti-glare screen
- Resolution: 1024 x 600
- Contrast ratio: 700:1
- Brightness: 500cd/m<sup>2</sup>
- Viewing angles:  
Side 85° x Top 85° x Bottom 85°

#### Power

- Power consumption: 10 Watts
- Current: 0.8 Amps

#### Durability & Standards

- Mechanical vibration: 4G
- Mechanical shock: 51G
- Operating temperature: -30 to +70°C
- CE marked
- E-Marked: UNECE R10 compliant
- HALT tested
- FCC approved
- IC approved

Model

Part No:

NEW

## AHD CAMERA 1080p

SELECT



VBV-7100C - High definition (1080p-PAL)	5466
VBV-7101C - High definition (1080p-NTSC)	5467
VBV-7190C - No audio. High definition (1080p-PAL)	5470
VBV-7191C - No audio. High definition (1080p-NTSC)	5471

• Viewing angle (HxVxD)  
110° x 60° x 127°

• IP69K

• Size (WxHxD)  
81 x 77 x 70mm

• 3 year warranty



### Features

- 4 high-power Infrared LEDs for ultra-low light performance
- Day / Night sensor
- Microphone
- Mirror view
- \* Backlight compensation
- Automatic white balance
- Sony CMOS 1/3" & Nextchip ISP
- TV System: AHD 1.0 (1080p)
- TV Lines: 800

### Power

- Power consumption: 3 Watts
- Current: 0.2 Amps

### Durability & Standards

- Mechanical vibration: 8.5G
- Mechanical shock: 51G
- Operating temperature: -30 to +80°C
- CE marked
- E-Marked: UNECE R10 compliant
- FCC approved
- IC approved

NEW

## AHD CAMERA 720p

SELECT



VBV-7000C - High definition (720p-PAL)	5464
VBV-7001C - High definition (720p-NTSC)	5465
VBV-7090C - No audio. IP69K High definition (720p-PAL)	5468
VBV-7091C - No audio. IP69K High definition (720p-NTSC)	5469

• Viewing angle (HxVxD)  
107° x 64° x 126°

• IP67

• Size (WxHxD)  
81 x 77 x 70mm

• 3 year warranty



### Features

- 4 high-power Infrared LEDs for ultra-low light performance
- Day / Night sensor
- Microphone
- Mirror view
- \* Backlight compensation
- Automatic white balance
- Sony CMOS 1/3" & Nextchip ISP
- TV System: AHD 1.0 (720p)
- TV Lines: 600

### Power

- Power consumption: 3 Watts
- Current: 0.2 Amps

### Durability & Standards

- Mechanical vibration: 8.5G
- Mechanical shock: 51G
- Operating temperature: -30 to +80°C
- CE marked
- E-Marked: UNECE R10 compliant
- FCC approved
- IC approved

Model

Part No:

**NEW**

**AHD EYEBALL CAMERA**

**SELECT**



<b>VBV-3000C</b>	- High Definition flush-mount eyeball camera Mirror view - (720p-PAL)	<b>5454</b>
<b>VBV-3001C</b>	- High Definition Flush-mount eyeball camera Mirror view - (720p-NTSC)	<b>5455</b>
<b>VBV-3020C</b>	- High Definition Flush-mount eyeball camera Normal view - (720p-PAL)	<b>5456</b>
<b>VBV-3021C</b>	- High Definition Flush-mount eyeball camera Normal view - (720p-NTSC)	<b>5457</b>



- **Viewing angle (HxVxD)**  
110 x 82 x 152° (25fps)  
111 x 80 x 153° (30fps)
- **IP69K**
- **Size (WxHxD)**  
57 x 42 x 70mm
- **3 year warranty**



**Features**

- 5 high power infrared LEDs for ultra-low light performance
- Day / Night sensor
- Lens swivel adjustment: 26° (Top) x 4° (Bottom) x 4° (Left) x 4° (Right)
- Lens rotation adjustment: ±180°
- Microphone
- Backlight compensation
- Automatic white balance
- 1/3" Sony CMOS
- TV System: AHD 1.0 (720p)
- TV lines: 600

**Power**

- Power consumption: 1.5 Watts
- Current consumption: 0.16 Amps

**Durability & Standards**

- Mechanical vibration: 8.5G
- Mechanical shock: 51G
- Operating temperature: -30 to +70°C
- CE marked
- E-Marked: UNECE R10 compliant
- FCC approved



**OPTIONAL EXTRAS**

<b>SM-3XX-25</b>	Surface mounting adapter (25mm deep)	<b>4596</b>
------------------	--------------------------------------	-------------

**AHD MINI CAMERA**

**SELECT**



<b>DMC-1031</b>	- High definition mini camera (internal use) (720p-PAL)	<b>5719</b>
<b>DMC-1035</b>	- High definition mini camera (internal use) (720p-NTSC)	<b>5721</b>



- **Viewing angle (HxVxD)**  
68 x 38 x 80°
- **IP30**
- **Size (WxHxD)**  
43 x 45 x 37.5mm
- **3 year warranty**



**Features**

- Mirror / Normal view
- Backlight compensation
- Automatic white balance
- CMOS - 1/3" ON-Semi ISP - Nextchip
- TV System: AHD 1.0 (720p)
- TV Lines: 900

**Power**

- Power consumption: 1.0 Watt
- Current: 0.55 Amps

**Durability & Standards**

- Mechanical vibration: 10G
- Mechanical shock: 51G
- Operating temperature: -30 to +85°C
- CE marked
- E-Marked: UNECE R10 compliant
- FCC approved
- IC approved

Model

Part No:

## AHD DOME CAMERA

SELECT



MD-60	- High definition dome camera (720p-PAL)	5737
MD-61	- High definition dome camera (720p-NTSC)	5738
MD-60(SW)	- High definition dome camera - Superwide view angle (720p-PAL)	5688
MD-61(SW)	- High definition dome camera - Superwide view angle (720p-NTSC)	5690
MD-60(W)	- High definition dome camera - Wide view angle (720p-PAL)	5696
MD-61(W)	- High definition dome camera - Wide view angle (720p-NTSC)	5698

• Viewing angle (HxVxD)  
68° x 38° x 80°  
(SW) 150° x 85° x 180°  
(W) 93° x 51° x 110°

• IP68

• Size (Diameter x H)  
76 x 59.5 mm

• 3 year warranty



### Features

- Dome camera with 150° movement range in all directions
- Can be used internally or externally
- Mirror / Normal view
- Backlight compensation
- Automatic white balance
- CMOS - 1/3" ON-Semi ISP - Nextchip
- TV System: AHD 1.0 (720p)
- TV Lines: 900
- TV Lines: 600 (SW & W)

### Power

- Power consumption: 1 Watt
- Current: 0.57 Amps

### Durability & Standards

- Mechanical vibration: 10G
- Mechanical shock 51G
- Operating temperature: -30 to +85°C
- CE marked
- E-Marked: UNECE R10 compliant
- FCC Approved
- IC Approved



## OPTIONAL EXTRAS

MD-50SM-30	- Surface mounting adapter (30mm deep)	5003
MD-50AM-15	- Angled surface mounting adapter (adds 15°)	5004
MD-50AM-25	- Angled surface mounting adapter (adds 25°)	5005

NEW

## AHD CAMERA CABLES

SELECT



VBV-H420	- 20 metre cable	5513
VBV-H415	- 15 metre cable	5514
VBV-H410	- 10 metre cable	5516
VBV-H405	- 5 metre cable	5519
VBV-H4025	- 2.5 metre cable	5522

Model

Part No:

**NEW AHD CAMERA MONITOR SYSTEMS**

**SELECT**

**VBV-770H-3000 - Single AHD flush-mount camera monitor system for rigid vehicles 6112**



- VBV-770HM - 7" AHD monitor 5611
- VBV-3000C AHD Camera 5454
- VBV-H420 - AHD 20m cable 5513

See individual products for detailed specifications and warranties

**VBV-770H-7000 - Single AHD camera monitor system for rigid vehicles 6111**



- VBV-770HM - 7" AHD monitor 5611
- VBV-7000C AHD Camera 5464
- VBV-H420 - AHD 20m cable 5513

See individual products for detailed specifications and warranties

**VBV-770H-3100 - Single AHD camera monitor system for small rigid vehicles 6113**



- VBV-770HM - 7" AHD monitor 5611
- VBV-3000C AHD Camera 5454
- VBV-H420 - AHD 10m cable 5516

See individual products for detailed specifications and warranties

**OPTIONAL EXTRA**

Add VBV-3000C (low mount) or VBV-3020C (high mount) side view camera + VBV-H405 (5m cable) to spot cyclists.

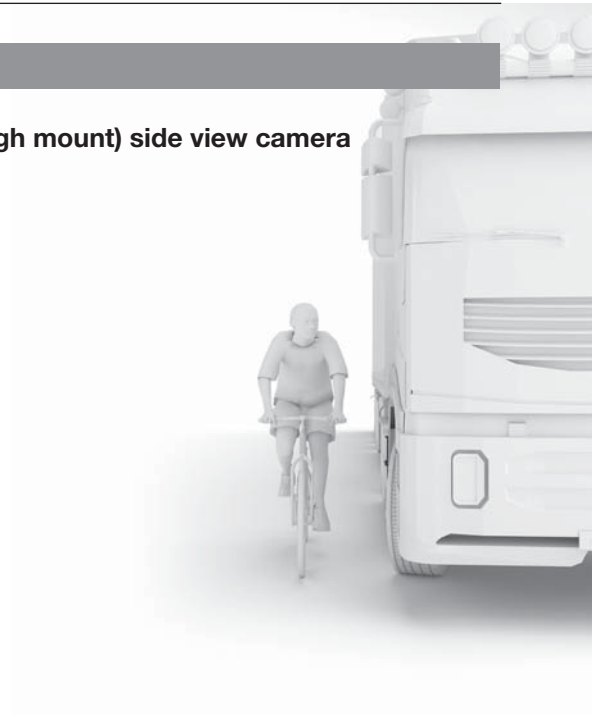

Model

Part No:

## 10.4" QUAD MONITOR

SELECT

VBV-7104FM - 10.4" Digital LCD Monitor

4474



- 12-24Vdc
- Size (WxHxD)  
267 x 193 x 30mm
- 3 year warranty

10.4"



Plus additional in-built image options

### Features

- 4 camera inputs
- 'Button-lock' anti-tamper feature
- 5 Auto-triggers
- Configurable trigger delay
- Mirror / Normal switching from menu
- On-screen distance markers
- Built-in speaker
- Sun shield
- Multi-lingual menus
- Auto-switching PAL / NTSC

### Picture Quality

- LED backlighting (gives 30,000 hours life)
- Anti-glare screen
- Resolution: 1024 x 768
- Contrast ratio: 500:1
- Brightness: 400cd/m<sup>2</sup>
- Viewing angles:  
Side 70° x Top 60° x Bottom 60°

### Power

- Power consumption: 31 Watts
- Current: 2.8 Amps

### Durability & Standards

- Mechanical vibration: 3G
- Mechanical shock: 50G
- Operating temperature: -20 to +70°C
- CE marked
- E-Marked: UNECE R10 compliant
- HALT tested
- \*Camera monitor system R46 approved

## 7" MONITOR

SELECT

VBV-770M - 7" Digital LCD monitor

4288

VBV-770M-S - 7" Digital LCD monitor

4697

Includes 1 x 5-pin input for connection to VBV-710C shutter camera

*Also available in High Definition model*



- 12-24Vdc
- Size (WxHxD)  
196 x 118 x 26mm
- 3 year warranty

7.0"



### Features

- 3 camera inputs
- 3 Auto-triggers
- Mirror / Normal switching from menu
- 'Button lock' anti-tamper feature
- On-screen distance markers
- Audio
- Sun shield
- Auto-dimmer
- Multi-lingual menus
- Auto-switching PAL / NTSC

### Picture Quality

- LED backlighting (gives 20,000 hours life)
- Anti-glare screen
- Resolution: 800 x 480
- Contrast ratio: 500:1
- Brightness: 400cd/m<sup>2</sup>
- Viewing angles:  
Side 70° x Top 50° x Bottom 70°

### Power

- Power consumption: 18 Watts
- Current: 1.5 Amps

### Durability & Standards

- Mechanical vibration: 4G
- Mechanical shock: 100G
- Operating temperature: -30 to +70°C
- CE marked
- E-Marked: UNECE R10 compliant
- HALT tested
- \*Camera monitor system R46 approved VBV-770M only

**Model**

**Part No:**

**5" MONITOR**

**SELECT**



**VBV-750M - 5" Digital LCD monitor**  
**VBV-750M-S - 5" Digital LCD monitor**

**4287**  
**4710**

Includes 1 x 5-pin input for connection to VBV-710C shutter camera



- 12-24Vdc
- Size (WxHxD)  
149.5 x 99 x 22mm
- 3 year warranty



**Features**

- 3 camera inputs
- 3 Auto-triggers
- Mirror / Normal switching from menu
- On-screen distance markers
- 'Button lock' anti-tamper feature
- Audio
- Sun shield
- Auto-dimmer
- Multi-lingual menus
- Auto-switching PAL / NTSC

**Power**

- Power consumption: 11.5 Watts
- Current: 0.95 Amps

**Durability & Standards**

- Mechanical vibration: 4G
- Mechanical shock: 100G
- Operating temperature: -30 to +70°C
- CE marked
- E-Marked: UNECE R10 compliant
- HALT tested

**Picture Quality**

- LED backlighting (gives 20,000 hours life)
- Anti-glare screen
- Resolution: 800 x 480
- Contrast ratio: 500:1
- Brightness: 350cd/m<sup>2</sup>
- Viewing angles: Side 70° x Top 50° x Bottom 70°

**7" QUAD MONITOR**

**SELECT**



**VBV-770FM - 7" Digital LCD monitor**

**4982**



- 12-24Vdc
- Size (WxHxD)  
182 x 122 x 27mm
- 3 year warranty

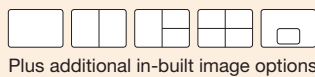

**Features**

- 4 camera inputs
- 'Button-lock' anti-tamper feature
- 5 Auto-triggers
- Mirror / Normal switching from menu
- On-screen distance markers
- Audio
- Sun shield
- Multi-lingual menus
- Auto-switching PAL / NTSC

**Power**

- Power consumption: 27 watts
- Current: 2.2 Amps

**Durability & Standards**

- Mechanical vibration: 4G
- Mechanical shock: 50G
- Operating temperature: -30 to +70°C
- CE marked
- E-Marked: UNECE R10 compliant

**Picture Quality**

- LED backlighting (gives 20,000 hours life)
- Anti-glare screen
- Resolution: 800 x 480
- Contrast ratio: 500:1
- Brightness: 400cd/m<sup>2</sup>
- Viewing angles: Side 70° x Top 50° x Bottom 70°

**CAMERA MONITOR SYSTEM ANCILLARIES**

**SELECT**



**BMM-019-ARM - 68mm replacement arm (Select range)**

**3348**

- 68mm mounting bracket arm
- Allows monitor to be dash-mounted in portrait position

A further range of camera/monitor brackets and mounting adapters is available. Please contact us for details

# Select Cameras

Model

Part No:

## CAMERA

SELECT



<b>VBV-700C</b>	- PAL	<b>1379</b>
<b>VBV-701C</b>	- NTSC	<b>2575</b>
<b>VBV-790C</b>	- Waterproof to IP69K, no audio PAL	<b>2724</b>
<b>VBV-791C</b>	- Waterproof to IP69K, no audio NTSC	<b>2842</b>

Also available in High Definition (720p & 1080p) models

- Viewing angle (HxVxD)  
88 x 68 x 115° PAL  
86 x 72 x 122° NTSC

• IP67

- Size (WxHxD)  
81 x 77 x 70mm

• 3 year warranty



### Features

- 4 high-power Infrared LEDs for ultra-low light performance
- Day / Night sensor
- Microphone
- Mirror view
- \* Backlight compensation
- Automatic white balance
- 1/3" Sharp CCD
- TV Lines: 620 PAL / 750 NTSC

### Power

- Power consumption: 3 Watts
- Current: 0.2 Amps

### Durability & Standards

- Mechanical vibration: 10G
- Mechanical shock: 51G
- Operating temperature: -30 to +70°C
- CE marked
- E-Marked: UNECE R10 compliant
- FCC approved
- HALT tested
- \*Camera monitor system R46 approved VBV-700C & VBV-790C only

## SHUTTER CAMERA

SELECT



<b>VBV-710C - Shutter camera</b>	<b>2808</b>
----------------------------------	-------------

Direct connection to VBV-770M-S and VBV-750M-S monitors via 5-pin 10m (VBV-L510) or 20m (VBV-L520) camera cable.

- Viewing angle (HxVxD)  
98 x 73 x 108°

• IP68 / IP69K

- Size (WxHxD)  
122 x 85 x 82mm

• 3 year warranty



### Features

- 4 high power infrared LEDs for ultra-low light performance
- Day / Night sensor
- Automatic Shutter
- Heater
- Microphone
- Mirror / Normal view
- Backlight compensation
- Automatic white balance
- 1/3" Sharp CCD
- TV System: PAL
- TV Lines: 580

### Power

- Max Power consumption: 6 Watts
- Max Current: 0.5 Amps

### Durability & Standards

- Mechanical vibration: 10G
- Mechanical shock: 50G
- Operating temperature: -30 to +70°C
- CE Marked
- E-Marked: UNECE R10 compliant



**Model**

**Part No:**

**EYEBALL CAMERA**

**SELECT**



<b>VBV-300C - Flush-mount eyeball camera - Mirror view - PAL</b>	<b>5211</b>
<b>VBV-301C - Flush-mount eyeball camera - Mirror view - NTSC</b>	<b>5213</b>
<b>VBV-320C - Flush-mount eyeball camera - Normal view - PAL</b>	<b>5215</b>
<b>VBV-321C - Flush-mount eyeball camera - Normal view - NTSC</b>	<b>5217</b>

*Also available in High Definition (720p) models*

- **Viewing angle (HxVxD)**  
**110 x 82 x 152° PAL**  
**111 x 80 x 153° NTSC**

• **IP69K**

• **Size (WxHxD)**  
**57 x 42 x 70mm**

• **3 year warranty**



**Features**

- 5 high power infrared LEDs for ultra-low light performance
- Day / Night sensor
- Lens swivel adjustment: 26° (Top) x 4° (Bottom) x 4° (Left) x 4° (Right)
- Lens rotation adjustment: ±180°
- Microphone
- Backlight compensation
- Automatic white balance
- 1/3" Sharp CCD
- TV System: PAL or NTSC
- TV lines: 780 PAL, 600 NTSC

**Power**

- Power consumption: 2.3 Watts
- Current consumption: 0.16 Amps

**Durability & Standards**

- Mechanical vibration: 8.5G
- Mechanical shock: 51G
- Operating temperature: -30 to +70°C
- CE marked
- E-Marked: UNECE R10 compliant
- FCC approved
- \*Camera monitor system R46 approved VBV-300C & VBV-320C only

**OPTIONAL EXTRAS**

<b>SM-3XX-25 Surface mounting adapter (25mm deep)</b>	<b>4596</b>
---	-------------

**CYLINDER CAMERA**

**SELECT**



<b>VBV-485C - Cylinder camera PAL</b>	<b>2199</b>
<b>VBV-481C - Cylinder camera NTSC</b>	<b>2843</b>

- **Viewing angle (HxVxD)**  
**91 x 77 x 123° PAL**  
**96 x 71 x 126° NTSC**

• **IP69K/IP68**

• **Size (Diameter x Length)**  
**35 x 50mm**

• **3 year warranty**



**Features**

- 9 LEDs for ultra-low light performance
- Day/night sensor
- Mirror view
- Backlight compensation
- Auto white balance
- 1/3" Sharp CCD
- TV Lines: 680 PAL  
800 NTSC

**Power**

- Power consumption: 1.9 Watts
- Current: 0.2 Amps

**Durability & Standards**

- Mechanical vibration: 10G
- Mechanical shock: 50G
- Operating Temperature: -30 to +70°C
- E-Marked: UNECE R10 compliant
- CE marked
- FCC approved VBV-481C only
- IC approved VBV-481C only

# Select Cameras

Model

Part No:

## DOME CAMERA

SELECT



MD-50 - Mini dome camera PAL	5735
MD-51 - Mini dome camera NTSC	5736
MD-50(SW) - Dome camera - Superwide view angle PAL	5683
MD-51(SW) - Dome camera - Superwide view angle NTSC	5686
MD-50(W) - Dome camera PAL	5692
MD-51(W) - Dome camera NTSC	5694

Also available in High Definition (720p) models



- Viewing angle (HxVxD)  
(SW) 150° x 85° x 180°  
(W) 93° x 51° x 110°
- IP68
- Size (Diameter x H)  
76 x 59.5 mm
- 3 year warranty



### Features

- Dome camera with 150° movement range in all directions
- Can be used internally or externally
- Mirror / Normal view
- Backlight compensation
- Automatic white balance
- CMOS - 1/3" ON-Semi ISP - Nextchip
- TV System: PAL or NTSC
- TV Lines: 600

### Power

- Power consumption: 1 Watt
- Current: 0.57 Amps

### Durability & Standards

- Mechanical vibration: 10G
- Mechanical shock 51G
- Operating temperature: -30 to +85°C
- CE marked
- E-Marked: UNECE R10 compliant
- FCC Approved
- IC Approved



## OPTIONAL EXTRAS

MD-50SM-30 - Surface mounting adapter (30mm deep)	5003
MD-50AM-15 - Angled surface mounting adapter (adds 15°)	5004
MD-50AM-25 - Angled surface mounting adapter (adds 25°)	5005

## MINI CAMERA

SELECT



DMC-1025 - Mini camera (internal use) PAL	5717
DMC-1021 - Mini camera (internal use) NTSC	5715

Also available in High Definition (720p) models

- Viewing angle (HxVxD)  
68 x 38 x 80°
- IP30
- Size (WxHxD)  
43 x 45 x 37.5mm
- 3 year warranty



### Features

- Mirror / Normal view
- Backlight compensation
- Automatic white balance
- CMOS - 1/3" ON-Semi ISP - Nextchip
- TV System: PAL or NTSC
- TV Lines: 600

### Power

- Power consumption: 1.0 Watt
- Current: 0.55 Amps

### Durability & Standards

- Mechanical vibration: 10G
- Mechanical shock: 51G
- Operating temperature: -30 to +60°C
- CE marked
- E-Marked: UNECE R10 compliant
- FCC approved
- IC approved

**Model**

**Part No:**

**SELECT CAMERA CABLES**

**SELECT**



- VBV-L430 - 30 metre cable
- VBV-L420 - 20 metre cable
- VBV-L415 - 15 metre cable
- VBV-L412 - 12 metre cable
- VBV-L410 - 10 metre cable
- VBV-L407 - 7 metre cable
- VBV-L406 - 6 metre cable
- VBV-L405 - 5 metre cable
- VBV-L403 - 3 metre cable
- VBV-L4025 - 2.5 metre cable

- 2108
- 1380
- 3150
- 3106
- 1386
- 3151
- 3152
- 1499
- 4977
- 1554



- VBV-L520 - 20 metre 5-pin shutter camera cable
- VBV-L510 - 10 metre 5-pin shutter camera cable
- VBV-L505 - 5 metre 5-pin shutter camera cable

- 3664
- 3663
- 4001

# Select Cables

Model

Part No:

## TRUCK/TRAILER CABLE KIT

SELECT

SK-15-05 - Truck and trailer cable kit for 3-camera Backeye®360

5066



- SP-15A-05 - 15-pin bulkhead socket for cab & cab-end connector plus 3x connections for Backeye®360 Select 5064
- SP-15B-05 15-pin bulkhead socket for trailer & trailer-end connector plus 3x connections for Backeye®360 Select 5065

- SC-15-01 Coiled shielded cable with 15-pin plugs 3268

## TRUCK/ DRAWBAR TRAILER CABLE KIT

SELECT

VSK-50E - Truck and drawbar trailer cable kit for two cameras

2540

Inclusive of VSK-50E-A Truck kit and VSK-30E-T Trailer kit



VSK-50E-A - Truck only kit 2541

VSK-30E-T - Trailer only kit 2542

- VBV-L420 - 20m cable for truck 1380
- VBV-L405 - 5m camera cable for truck camera 1499
- VCS-020 - Two-way camera selector 1844
- 1 x VSP-47A - 7-pin camera bulkhead socket for truck rear 1847
- SC-07-24S - Coiled cable with 7-pin sockets 1227

- VBV-L420 - 20m cable for trailer 1380
- VSP-47B - 7-pin camera bulkhead socket for trailer 1846

## TRUCK/DRAWBAR TRAILER CABLE KIT

SELECT

VSK-505E - Truck and drawbar trailer cable kit for two Select shutter cameras

4005



- VBV-L420 - 20m cable for truck 1380
- VBV-L520 - 20m camera cable for truck camera 3664
- VBV-L505 - 5m camera cable for cab 4001
- VCS-020 - Two-way camera selector 1844
- 2 x AC-035 - 5-pin to 4-pin shutter camera adapter 3702

- VSP-57A 7-Pin bulkead socket for cab & cab-end camera connector 3869
- VSP-57B 7-pin bulkhead socket for trailer & trailer-end camera connector 3870
- SC-07-24S - Coiled cable with 7-pin plugs 1227

Model

Part No:

**TRUCK/TRAILER CABLE KIT**

**SELECT**



**VSK-31E - Truck and trailer cable kit - unique pin layout**

**2539**

Inclusive of VSK-31E-T - Trailer kit



SP-7A SC-7 SP-7B  
(Select connector via supplied adapter cables)

- VBV-L410 - 10m cable for cab 1386
- SP-7A - 7-pin bulkhead socket for cab & cab-end camera connector (unique pin layout) 1827
- AC-014 - Adapter cable 2094
- SC-7 - Coiled cable with 7-pin plugs (unique pin layout) 1829

**VSK-31E-T - Trailer only kit 2543**

- VBV-L420 - 20m cable for trailer 1380
- AC-006 - Adapter cable 1983
- SP-7B - 7-pin bulkhead socket for trailer & trailer-end camera connector (unique pin layout) 1828

**TRUCK/TRAILER CABLE KIT**

**SELECT**



**VSK-30E - Truck and trailer cable kit**

**2538**

Inclusive of SK-30E-T - Trailer only kit



VSP-47A SC-07-24S VSP-47B

- VBV-L410 - 10m cable for cab 1386
- VSP-47A - 7-pin bulkhead socket for cab & cab-end camera connector 1847
- SC-07-24S - Coiled cable with type 24S 7-pin plugs 1227

**VSK-30E-T - Trailer only kit 2542**

- VBV-L420 - 20m extension cable for trailer 1380
- VSP-47B - 7-pin bulkhead socket for trailer & trailer-end camera connector 1846

**TRUCK/TRAILER CABLE KIT**

**SELECT**



**VSK-305E - Truck and trailer cable kit for Select shutter camera**

**3871**



VSP-57A SC-07-24S VSP-57B

- VBV-L510 10m cable for cab 3663
- VBV-L520 20m cable for trailer 3664
- VSP-57A 7-pin bulkhead socket for cab & cab-end camera connector 3869

**VSP-57B 7-pin bulkhead socket for trailer & trailer-end camera connector 3870**

- SC-07-24S - Coiled cable with type 24S 7-pin plugs 1227

Model

Part No:

## CAMERA MONITOR SYSTEMS

SELECT

VBV-770-001DW - Single wireless camera monitor system for articulated vehicles

4843



• VBV-770M - 7" monitor	4288
• VBV-700C - camera	1379
• VBV-L420 - 20m cable	1380
• DW-1000-TX - digital wireless transmitter	4043
• DW-1000-RX - digital wireless receiver	4044
• AC-006 - camera adapter	1983
• AC-007 - monitor adapter	1984

See individual products for detailed specifications and warranties

VBV-770-001 - Single camera monitor system for articulated vehicles

4767



• VBV-770M - 7" monitor	4288	• SC-07-24S - Coiled cable with type 24S 7-pin plugs	1227
• VBV-700C - camera	1379	• VBV-L420 - 20m extension cable for trailer	1380
• VBV-410 - 10m cable for cab	1386	• VSP-47B - 7-pin bulkhead socket for trailer & trailer-end camera connector	1846
• VSP-47A - 7-pin bulkhead socket for cab & cab-end camera connector	1847		

See individual products for detailed specifications and warranties

VBV-770-101 - Single shutter camera monitor system for articulated vehicles

4772



• VBV-770M-S - 7" monitor	4697	• VSP-57B 7-pin bulkhead socket for trailer & trailer-end camera connector	3870
• VBV-710C - shutter camera	2808	• SC-07-24S - Coiled cable with 7-pin sockets	1227
• VBV-L510 - 10m cable for cab	3663		
• VBV-L520 - 20m cable for trailer	3664		
• VSP-57A 7-pin bulkhead socket for cab & cab-end camera connector	3869		

See individual products for detailed specifications and warranties

**Model**

**Part No:**

**CAMERA MONITOR SYSTEMS**

**SELECT**

**VBV-770-300 - Single flush-mount camera monitor system for rigid vehicles**

**4777**



- VBV-770M - 7" monitor **4288**
- VBV-300C - flush-mount camera **5211**
- VBV-L420 - 20m cable **1380**

See individual products for detailed specifications and warranties

**R46**  
APPROVED

**VBV-770-000 - Single camera monitor system for rigid vehicles**

**4692**



- VBV-770M - 7" monitor **4288**
- VBV-700C - camera **1379**
- VBV-L420 - 20m cable **1380**

See individual products for detailed specifications and warranties

**R46**  
APPROVED

**VBV-770-100 - Single shutter camera monitor system for rigid vehicles**

**4695**



- VBV-770M-S - 7" monitor **4697**
- VBV-710C - shutter camera **2808**
- VBV-L520 - 20m cable **3664**

See individual products for detailed specifications and warranties

**VBV-750-000 - Single camera monitor system for rigid vehicles**

**4705**



- VBV-750M - 5" monitor **4287**
- VBV-700C - camera **1379**
- VBV-L420 - 20m cable **1380**

See individual products for detailed specifications and warranties

**OPTIONAL EXTRA**

Add VBV-300C (low mount) or VBV-320C (high mount) side view camera + VBV-L405 (5m cable) to spot cyclists.



Model

Part No:

## CAMERA MONITOR SYSTEMS

SELECT

**VBV-770-310 - Single flush-mount camera monitor system for small rigid vehicles 4781**



- VBV-770M - 7" monitor **4288**
- VBV-300C - flush-mount camera **5211**
- VBV-L410 - 10m cable **1386**

See individual products for detailed specifications and warranties

**R46**  
APPROVED

**VBV-750-310 - Single flush-mount camera monitor system for small rigid vehicles 4780**



- VBV-750M - 5" monitor **4287**
- VBV-300C - flush-mount camera **5211**
- VBV-L410 - 10m cable **1386**

See individual products for detailed specifications and warranties



Model

Part No:

**NEW** CAMERA MONITOR SYSTEM **ESSENTIAL**

**VBV-670-000 - PAL Camera monitor system** **5774**  
**VBV-671-000 - NTSC Camera monitor system** **5816**

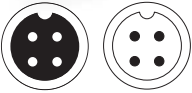

- **Camera Viewing angle (HxVxD)**  
89 x 65 x 115° PAL  
89 x 65 x 114° NTSC
- IP67
- **Camera Size (WxHxD)**  
76 x 59 x 52mm
- **Monitor Size (WxHxD)**  
205 x 126 x 26mm
- 1 year warranty



**Contents**

- 1 x VBV-670M monitor
- 1 x monitor sunshield
- 1 x monitor bracket
- 1 x VBV-63XC camera
- 1 x 20m VBV-L4020 extension cable
- Fitting kit

**Camera Features**

- Normal view
- 1/3" PixelPlus CMOS
- TV Lines: 425

**Monitor Features**

- 2 camera inputs
- 1 auto trigger
- Sun shield
- Multi-lingual menus
- Normal/Mirror via OSD menu

**Picture Quality**

- Monitor resolution: 800x400
- Contrast ratio: 500:1
- Brightness: 250 cd/m<sup>2</sup>
- Monitor viewing angles:  
Side 70° x Top 45° Bottom 65°

**Power**

- Power consumption: 4.2 Watts
- Current: 0.4 Amps

**Durability & Standards**

- Mechanical vibration:  
Camera: 8.5G Monitor: 4G
- Operating temperature: -30 to +70°C
- CE marked
- FCC approved



**TO CONNECT AN ADDITIONAL CAMERA**

**VBV-630C - Essential Camera - PAL** **5772**  
**VBV-631C - Essential Camera - NTSC** **5817**

**VBV-L4020 - 20m Essential extension cable** **5773**

**CAMERA MONITOR SYSTEM** **ESSENTIAL**

**VBV-650-000 - PAL Single-camera monitor system** **4765**  
**VBV-650-000N - NTSC Single-camera monitor system** **4766**

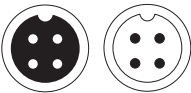

- **Camera Viewing angle (HxVxD)**  
81 x 59 x 106° PAL  
81 x 59 x 108° NTSC
- IP67
- **Camera Size (WxHxD)**  
65 x 59 x 55mm
- **Monitor Size (WxHxD)**  
150 x 99 x 31mm
- 1 year warranty



**Contents**

- 1 x VBV-650M monitor
- 1 x monitor bracket
- 1 x VBV-620C camera PAL or VBV-621C camera NTSC
- 1 x 20m VBV-L4020 extension cable
- Fitting kit

**Camera Features**

- Mirror view
- CMOS
- TV Lines: 420

**Monitor Features**

- 1 camera inputs

**Picture Quality**

- Monitor resolution: 640x480
- Monitor viewing angles:  
Side 70° x Top 50° Bottom 70°

**Power**

- Power consumption: 2 Watts

**Durability & Standards**

- Operating temperature: -10 to +70°C



































# Adapter Cables





















**Model**

**Part No:**

## BRIGADE CAMERA MONITOR ADAPTERS

	 	AC-006 - Connects Select camera (not shutter) to Elite cable	1983
	 	AC-007 - Connects Select monitor to Elite cable	1984
	 	AC-014 - Connects Elite camera to Select cable	2094
	 	AC-014(5M) - Connects Elite camera to Select cable, 5m long	5049
	 	AC-020 - Connects Elite monitor to Select cable	2590
	 	AC-035 - 5-pin to 4-pin Select shutter camera adapter	3702
	 	AC-055(5M) - 5-pin to 4-pin Select cable, 5m long	4267
	  	AC-305 - Splitter cable connects 1 x BN360-200 camera to MDR & ECU	4903
	  	AC-306 - Splitter cable connects 1 x (Non HD) Select camera to MDR & monitor	4904
	  	AC-307 - Splitter cable connects 1 x Elite camera to MDR & Monitor	4905

## MISCELLANEOUS CAMERA MONITOR ADAPTERS

	 	AC-056 - Connects Select camera to Orlaco monitor	4401
	 	AC-062 - Connects Elite camera to Orlaco monitor	4691
	 	AC-063 - Connects Elite camera to Orlaco monitor, screw fit	4925
	 	AC-066 - Connects Orlaco camera to Elite monitor	5027
	 	AC-067 - Connects Orlaco camera to Select monitor	5028
	 	AC-24-12(009) - In-line 24/12Vdc converter - Select camera to Mekra 507405 monitor	4926
	 	AC-308 - Splitter cable to connect MDR to Mekra 507405 CMS	4949

**Model**

**Part No:**

**OEM CAMERA MONITOR ADAPTERS**

		<b>AC-041 - Connects Elite camera to John Deere 7-pin amp output</b>	<b>4245</b>
		<b>AC-042 - Connects Select camera to John Deere 7-pin amp output</b>	<b>4246</b>
		<b>AC-044 - Connects Select camera to Molex M12 (Fendt)</b>	<b>4279</b>
		<b>AC-045 - Connects Elite camera to Molex M12 (Fendt)</b>	<b>4280</b>
		<b>AC-068 - Connects Select camera to MAN Harman unit with camera prep</b>	<b>5234</b>
		<b>AC-069 - Connects Select camera to MAN/Scania Harman unit without camera prep</b>	<b>5318</b>
		<b>AC-24-12(002) - In-line 24/12Vdc converter - Elite camera to Mercedes monitor</b>	<b>4266</b>
		<b>AC-24-12(004) - In-line 24/12Vdc converter - Select camera to MAN MMT HSD</b>	<b>4281</b>
		<b>AC-24-12(006) - In-line 24/12Vdc converter - Select camera to Volvo FH(4) &amp; FM(4)</b>	<b>4719</b>
		<b>AC-24-12(007) - In-line 24/12Vdc converter - Select camera to Iveco connect system</b>	<b>4762</b>
	<b>AC-24-12(008) - In-line 24/12Vdc converter - Select camera to Mercedes Sprinter</b>	<b>4763</b>	

A further range of OEM-specific adapters to connect Brigade cameras to factory-fit monitors is available

**GENERAL CAMERA MONITOR ADAPTERS**

		<b>AC-016 - Connects AV to Camera input of Elite monitor</b>	<b>2150</b>
		<b>AC-019 - Connects Elite camera to male phono (video only)</b>	<b>2589</b>
		<b>AC-021 - Connects BNC/FLIR PathFindIR camera to Elite cable</b>	<b>2704</b>
		<b>AC-024 - Connects AV to Select monitor</b> <small>(video &amp; audio input, 12Vdc output)</small>	<b>3183</b>
		<b>AC-028 - Connects AV to Select cable</b>	<b>3335</b>
		<b>AC-064 - Connects Elite camera to BNC adapter cable</b>	<b>4948</b>

**Model**

**Part No:**

## DIGITAL WIRELESS CONNECTION SYSTEM



Elite



Select

**DW-1000-TX - Digital Wireless Transmitter**  
**DW-1000-RX - Digital Wireless Receiver**

**4043**  
**4044**

- Digital technology
- 12-24Vdc
- 1 camera input
- IP69K (Transmitter)
- Size (WxHxD)  
113 x 114 x 31mm
- 3 year warranty

### Features

- Image Latency: 200 milliseconds
- No need for retractable coiled cables
- Reduces installation time
- Re-pair facility allows for interchangeable trailers
- Triggered by reverse gear
- TV System PAL/NTSC
- Secure connection

### Power

- Maximum Current Amps:  
TX: 0.85 RX: 0.17

- Power consumption:  
TX: 9.8 Watts RX: 2.2 Watts

### Durability & Standards

- Operating temperature:  
-40 to +70°C
- Mechanical vibration: 6G
- Mechanical shock: 20G
- CE marked
- E-Marked: UNECE R10 compliant

Includes connectors/adapters for both Elite and Select range cameras and monitors. Not AHD compatible

## CAMERA MONITOR SYSTEM ANCILLARIES



Elite



Select



**CS-020 - Two-way camera selector (Elite range connectors)**

**1571**

**VCS-020 - Two-way camera selector (Select range connectors)**

**1844**

- Allows a 2nd camera to be connected to a monitor
- 2nd camera view selected by trigger wire
- Full screen view only
- 2 year warranty

Not AHD compatible

## CAMERA MONITOR SYSTEM ANCILLARIES



**LS-60-A - Speed switch**

**4851**

- 12-24Vdc
- Auto-triggers safety equipment at the designated speed
- Size (WxHxD)  
44 x 16 x 64mm
- 2 year warranty

### Features

- Normally closed - safety device on by default, turning off at designated speed
- 10 speed threshold settings
- Compact size
- Easy to install and set up
- Short circuit protection on camera inputs
- Reverse polarity protected

### Power

- Power consumption: 21.6 Watts
- Max current: 1.8 Amps
- Switch Output max. current: 1.2 Amps

### Durability & Standards

- Mechanical vibration: 10G
- Mechanical shock: 50G
- Operating temperature: -40 to +85°C
- CE marked
- E-Marked: UNECE R10 compliant

### Notes:

- A relay is required if connected to a device that is higher than 1.2 Amps
- Not compatible with HD systems

**Model**

**Part No:**

**CAMERA MONITOR SYSTEM ANCILLARIES**

**SELECT**

**SS-002 - Twin camera screen splitter (Select range connectors)**

**3044**

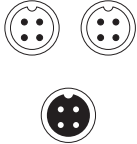

- 12-24Vdc
- 2 camera inputs
- Size (WxHxD)  
147 x 37 x 78mm
- 2 year warranty

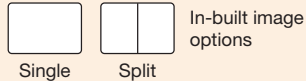

**Features**

- Offers split-screen option for monitors without in-built functionality
- 3 trigger inputs per camera
- Shutter camera compatible with adapters (Elite - AC-035) (Select - TS-1000-ECU)
- TV System: PAL / NTSC
- Manual Mirror/Normal switching - choose from horizontal normal/mirror or vertical normal/flip
- Short circuit protection on camera inputs
- Reverse polarity protected

**Power**

- Power Consumption: 8.4 Watts
- Current: 0.7 Amps

**Durability & Standards**

- Mechanical vibration: 10G
- Mechanical shock: 50G
- Operating temperature: -30 to +70°C
- CE marked
- E-Marked: UNECE R10 compliant
- FCC approved
- IC approved

Adapter required for Elite range monitors  
Not AHD compatible

**CAMERA MONITOR SYSTEM ANCILLARIES**

**ELITE**

**EDM-50 - Multi-camera module and screen splitter (Elite range connectors)**

**2152**



- 12-24Vdc
- 4 camera inputs
- Size (WxHxD)  
154 x 28 x 105mm
- 2 year warranty

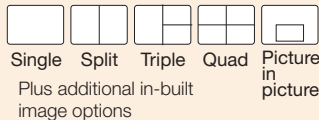

**Features**

- Shutter camera compatible (inputs 1,2&3)
- AV input to accept DVD, sat nav or other add-ons
- 5 manual or auto-triggers for each camera
- On screen distance markers
- Mirror / Normal image switch for each camera
- Selectable camera audio
- Auto-scanning function
- Adapter required for Select range monitors

**Power**

- Power consumption: 20 Watts
- Current: 2A

**Durability & Standards**

- Mechanical vibration: 5G
- Operating temperature: -25 to +70°C
- CE marked
- E-Marked: UNECE R10 compliant

Not AHD compatible

**CAMERA MONITOR SYSTEM ANCILLARIES**

**ELITE**

**SC-1000-ECU - Shutter camera module**

**3666**



- Allows BE-810C shutter camera to function on non-shutter enabled inputs on Elite range monitors (using Elite range cables)

- Adapter required for Select range monitors

- Current: 2A
- CE marked
- E-Marked: UNECE R10 compliant

- 2 year warranty



# MDR

# Mobile Digital Recording

## Providing your witness

Brigade's Mobile Digital Recording (MDR) systems are now capable of capturing vehicle data and footage from up to 16 vehicle-mounted cameras. The MDR range includes models with 4G and WiFi connectivity capabilities, allowing data to be accessed from the recorder without having to physically go to the vehicle.

To take full advantage of the benefits of 4G connectivity, Brigade provide Bridge, a fully managed service for 4G enabled systems so that operators do not have to set up and maintain their own servers and manage SIMs and mobile data.

New IP Cameras and Network Expansion Modules mean that up to 6 cameras can be connected to our 4-channel MDR and up to 16 cameras can be connected to our 8-channel MDR.

MDRs are compatible with all Brigade Backeye® camera monitor systems, including Backeye®360.

MDRs are compatible with Brigade's Backeye® camera monitor systems, IP cameras and Backeye®360 - BN360-200.

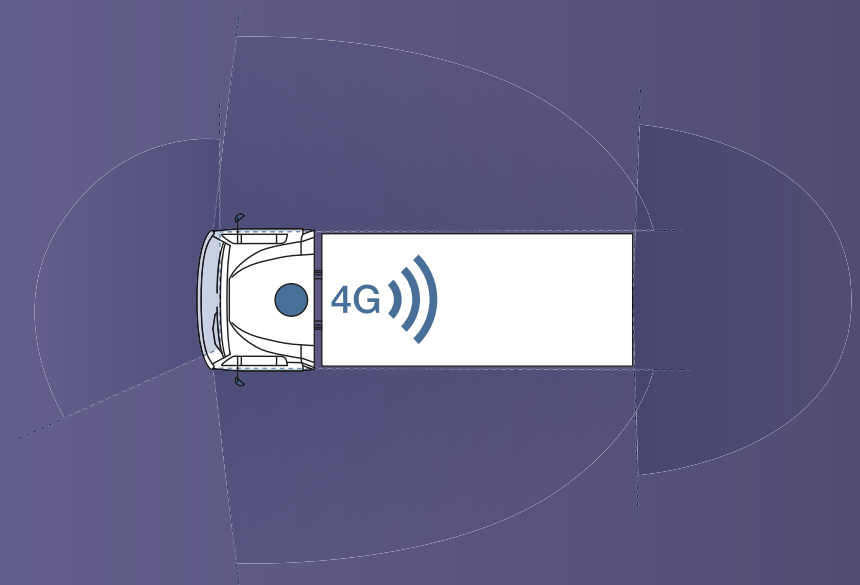

# BRIDGE

## MDR 4G Hosted Service

The MDR range includes models with 4G connectivity capabilities, allowing data to be accessed from the recorder without having to physically go to the vehicle.

In order to take full advantage of the benefits of 4G connectivity, Brigade now provide Bridge, a fully managed service for 4G enabled systems so that operators do not have to set up and maintain their own servers and manage SIMs and mobile data.



### Benefits of having remote access to the MDR can include:

- **Playback of historical footage and metadata from MDR or server** - Metadata includes: GPS location, speed, G-force, events and alarms.
- **Vehicle tracking** - Includes: GPS location, speed and alarms. Dual-screen support with dedicated location map.
- **Live view of vehicle cameras and metadata** - Metadata includes: GPS location, speed and alarms. Up to 64 cameras can be viewed from multiple MDRs on one screen.
- **Download footage**
  - **Scheduled:** one-off download to the server that will commence once vehicle is online.
  - **Automatic:** Pre-alarm and post-alarm footage (e.g. 30 seconds) will automatically save to the server.
  - **Manual:** Download historical footage from the MDR to local storage.
- **Geo-fencing** - Easily set up geographical boundaries to know when your vehicle enters and/or leaves areas.

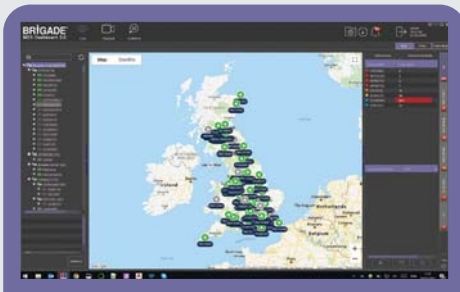

Vehicle Tracking on MDR Dashboard  
PC software and MDR App

Example of 4-channel playback  
MDR Dashboard PC software

### All Bridge packages include

- 4G connection
- Competitively-priced 12 month contract, rolling thereafter
- SIM card
- Remote access to MDR via secure cloud server
- Technical helpline and online tutorials
- Access to data via MDR Apps for iOS and Android systems
- Access to data via MDR Dashboard PC software: Windows OS required (minimum Windows 7)

For further information, visit [brigade-electronics.com/bridge](http://brigade-electronics.com/bridge)





At the time of print, 4G Hosted Services only available in selected countries.



**Model**

**Part No:**

**MOBILE DIGITAL RECORDER**

	<b>MDR-508-2000</b>	<b>- 8 channel 2TB hard disk recorder</b>	<b>5577</b>
	<b>MDR-508-1000</b>	<b>- 8 channel 1TB hard disk recorder</b>	<b>5126</b>
	<b>MDR-508GW-2000</b>	<b>- 8 channel 2TB hard disk recorder with WiFi and 4G</b>	<b>5585</b>
	<b>MDR-508GW-1000</b>	<b>- 8 channel 1TB hard disk recorder with WiFi and 4G</b>	<b>5127</b>
	<b>MDR-508G-2000</b>	<b>- 8 channel 2TB hard disk recorder with 4G</b>	<b>5583</b>
	<b>MDR-508G-1000</b>	<b>- 8 channel 1TB hard disk recorder with 4G</b>	<b>5128</b>
	<b>MDR-508W-2000</b>	<b>- 8 channel 2TB hard disk recorder with WiFi</b>	<b>5579</b>
	<b>MDR-508W-1000</b>	<b>- 8 channel 1TB hard disk recorder with WiFi</b>	<b>5129</b>



- **9-32Vdc**
- **8 camera inputs - Supports AHD High definition cameras**
- **8 trigger/alarm inputs**
- **Lockable and interchangeable Hard Drive Unit**
- **Fast, easily downloadable recordings and data**
- **Size (WxHxD) 224 x 85 x 221mm**
- **3 year warranty**

- Main Contents**
- Mobile Digital Recorder with 2.5" SATA HDD caddy unit
  - Wired Mouse
  - 64Gb industrial grade Class 10 SD card
  - Input / Output Cable
  - Power Cable
  - GPS Antenna
  - 4G Antenna (G and GW models)
  - Wi-Fi Antenna (W and GW models)
  - USB A to B Cable (3.0)
  - Security Key
  - Bracket and Fixings
- Features**
- Remotely access MDR units using wireless (WiFi models only) and/or Mobile network (4G models only)
  - Mobile apps for remote view (WiFi/4G models only)
  - Geo-fencing (WiFi/4G models only)
  - Mobile Standards: 2G/3G/4G
  - Audio (cameras must have microphones)
  - Robust aluminum housing
  - Anti-vibration mounting allows for installation at any angle
  - Built-in GPS
  - Internal G-sensor and built-in buzzer
  - Recordings saved to hard disk (protected by non-visible digital watermark) and in-built Mirror recording onto 64Gb SD card
  - Recording modes: normal, alarm and timer (all watermarked)
  - Configurable alarm trigger settings (speed, G-force, motion detection, video loss, voltage)
  - Record images prior to alarm activation and after vehicle switched off

- MDR-Dashboard (full player) and MDR-Player (portable) with Google and MS Bing maps (English only)
  - Search by date, time or triggered events
  - Multi-level password protected access
  - Hard drive unit directly pluggable to PC via USB port
  - 8 x trigger Inputs, 2x trigger outputs and 1x12V power output
  - Built-in HDD heater
  - MDR Control using USB Mouse or optional IR remote control
  - USB 3.0 connection
  - TV System: PAL/NTSC/AHD
  - Compatible with Brigade's vehicle CCTV camera monitor systems, IP cameras and Backeye@360 systems
- Image and Audio Quality**
- High quality H.264 image compression
  - ADPCM - audio compression
  - Choice of 8 low to high resolution settings
  - Record at between 1 and 25 frames per second, per channel
- Power**
- Max power consumption: 80 Watts
  - Current: 6.6 Amps
- Durability & Standards**
- Mechanical vibration: 1G
  - Mechanical shock: 51G
  - Operating temperature: -40 to +70°C
  - E-Marked: UNECE R10 compliant
  - CE marked
  - FCC approved
  - IC approved
  - RoHS2 Compliant

**OPTIONAL EXTRA**



**Expand the channel capability of the MDR with the addition of an Expansion Module and IP cameras:**  
See pages 52-53

**IP-EM4 - Expansion Module adds 4 channels to MDR-508 = 12 channels**

**IP-EM8 - Expansion Module adds 8 channels to MDR-508 = 16 channels**

# Mobile Digital Recorders

Model

Part No:

## MOBILE DIGITAL RECORDER

	<b>MDR-504-2000</b>	- 4 channel 2TB hard disk recorder	<b>5563</b>	
	<b>MDR-504-1000</b>	- 4 channel 1TB hard disk recorder	<b>5561</b>	
		<b>MDR-504GW-2000</b>	- 4 channel 2TB hard disk recorder with WiFi and 4G	<b>5575</b>
		<b>MDR-504GW-1000</b>	- 4 channel 1TB hard disk recorder with WiFi and 4G	<b>5573</b>
	<b>MDR-504G-2000</b>	- 4 channel 2TB hard disk recorder with 4G	<b>5571</b>	
	<b>MDR-504G-1000</b>	- 4 channel 1TB hard disk recorder with 4G	<b>5569</b>	
	<b>MDR-504W-2000</b>	- 4 channel 2TB hard disk recorder with WiFi	<b>5567</b>	
	<b>MDR-504W-1000</b>	- 4 channel 1TB hard disk recorder with WiFi	<b>5565</b>	



- 9-32Vdc
- 4 camera inputs - Supports AHD High definition cameras
- 8 trigger/alarm inputs
- Lockable and interchangeable Hard Drive Unit
- Fast, easily downloadable recordings and data
- Size (WxHxD)  
190 x 75 x 222mm
- 3 year warranty

### Main Contents

- Mobile Digital Recorder with 2.5" SATA HDD caddy unit
- Wired Mouse
- 32Gb industrial grade Class 10 SD card
- Input / Output Cable
- Power Cable
- GPS Antenna
- 4G Antenna (G and GW models)
- Wi-Fi Antenna (W and GW models)
- USB A to B Cable (3.0)
- Security Key
- Bracket and Fixings

### Features

- Remotely access MDR units using wireless (WiFi models only) and/or Mobile network (4G models only)
- Mobile apps for remote view (WiFi/4G models only)
- Geo-fencing (WiFi/4G models only)
- Mobile Standards: 2G/3G/4G
- Audio (cameras must have microphones)
- Robust aluminum housing
- Anti-vibration mounting allows for installation at any angle
- Built-in GPS
- Internal G-sensor and built-in buzzer
- Recordings saved to hard disk (protected by non-visible digital watermark) and in-built Mirror recording onto SD card
- Recording modes: normal, alarm and timer (all watermarked)
- Configurable alarm trigger settings (speed, G-force, motion detection, video loss, voltage)
- Record images prior to alarm activation and after vehicle switched off

- MDR-Dashboard (full player) and MDR-Player (portable) with Google and MS Bing maps (English only)
- Search by date, time or triggered events
- Multi-level password protected access
- Hard drive unit directly pluggable to PC via USB port
- 8 x trigger Inputs, 2x trigger outputs and 1x12V power output
- Built-in HDD heater
- MDR Control using USB Mouse or optional IR remote control
- USB 3.0 connection
- TV System: PAL/NTSC/AHD
- Compatible with Brigade's vehicle CCTV camera monitor systems, IP cameras and Backeye@360 systems

### Image and Audio Quality

- High quality H.264 image compression
- ADPCM - audio compression
- Choice of 8 low to high resolution settings
- Record at between 1 and 25 frames per second, per channel

### Power

- Max power consumption: 60 Watts
- Current: 5 Amps

### Durability & Standards

- Mechanical vibration: 1G
- Mechanical shock: 51G
- Operating temperature: -40 to +70°C
- E-Marked: UNECE R10 compliant
- CE marked
- FCC approved
- IC approved
- RoHS2 Compliant

## OPTIONAL EXTRA

Expand the channel capability of the MDR with the addition of an Expansion Module and IP cameras:

See pages 52-53



**IP-EM4 - Expansion Module adds 2 channels to MDR-504 = 6 channels**

**Model**

**Part No:**

**500 SERIES MOBILE DIGITAL RECORDER ACCESSORIES**



**AC-305 - Splitter cable connects 1 x Backeye®360 BN360-200 camera to MDR & ECU**

**4903**

**AC-306- Connects 1 x Select camera to MDR and monitor**

**4904**

**AC-307- Connects 1 x Elite camera to MDR and monitor**

**4905**



**MDR-RP01- Remote status & interface panel with panic button**

**4872**



**MDR-06RPC- 6m cable for Remote status & interface panel**

**4873**

**MDR-GS-02- External G-sensor**

**4988**

**MDR-03GSC- 3m G-sensor cable**

**4874**



**MDR-508GW-EXP-0 - Wi-Fi & 4G upgrade Expansion Module**  
For MDR-508 models only. SD card not included

**5309**

**MDR-508G-EXP-0 - 4G upgrade Expansion Module**  
For MDR-508 models only. SD card not included

**5310**

**MDR-508W-EXP-0 - Wi-Fi upgrade Expansion Module**  
For MDR-508 models only. SD card not included

**5311**



**MDR-500-500-MCU - Caddy unit with 500GB HDD**

**5132**

**MDR-500-1000-MCU - Caddy unit with 1TB HDD**

**5157**

**MDR-500-2000-MCU - Caddy unit with 2TB HDD**

**5330**

**SD-32GB-IND - 32GB industrial grade Class 10 SD card**

**4875**

**SD-64GB-IND - 64GB industrial grade Class 10 SD card**

**4876**



**MDR-FPB32-01 - External SD Mirror-recorder in fireproof housing**  
with 32GB industrial grade Class 10 SD card

**4896**

# IP Cameras & Expansion Modules

## What are IP cameras & Expansion Modules?

An Internet Protocol (IP) camera is a high-definition digital camera with its own IP address. Instead of transmitting video over a video cable to a monitor or MDR, the IP camera transmits digital video to the MDR over a data connection (ethernet cable) where the images are saved to the HDD memory.

Brigade Expansion Modules use Power Over Network (PON) Switch technology to expand the channel capability of the MDR by transmitting digital video images from IP cameras over the top of existing analogue video cables/signals. The MDR on-screen display allows easy camera set up without need for specific IP camera knowledge

**Benefit:** Connecting IP cameras increases the number of channels available on the MDR:

MDR-504	- 4 x Analogue channels plus 1 x IP channel	= 5 channels
MDR-504 and PON switch	- 4 x Analogue channels plus 2 x IP channels	= 6 channels
MDR-508	- 8 x Analogue channels plus 1 x IP channel	= 9 channels
MDR-508 and PON switch	- 8 x Analogue channels plus up to 8 x IP channels	= 16 channels

**Model**

**Part No:**

### NEW IP CAMERA



#### IP-1000C - Internal forward-facing camera

5935

- **Viewing angle (HxVxD)**  
87 x 48 x 95°
- **IP20**
- **Size (WxHxD)**  
75 x 122 x 40mm
- **3 year warranty**



#### Features

- High-definition picture quality
- Windscreen flush-mounted to avoid reflections
- Microphone
- Normal view - mirror view via OSD settings or IP web interface
- Backlight compensation
- Automatic white balance
- Supports web browser access
- Fast setup feature in MDR 500 series to auto-assign camera IP address
- Picture Elements: 1920(H) x 1080(V)
- Imaging device: CMOS
- TV Lines: 800

#### Power

- Power consumption: 2.5 Watts
- Current: 0.2 Amps

#### Durability & Standards

- Mechanical vibration: 4.7G
- Mechanical shock: 51G
- Operating temperature: -40 to +70°C
- Video output signal: H.264 or H.265
- Network protocol: MDR5, ONVIF, TCP/IP, HTTP, DHCP, NTP, FTP
- CE marked
- E-Marked: UNECE R10 compliant
- FCC approved
- IC approved

**Note:** For use with MDR only

### NEW IP CAMERA



#### IP-1200C - Surface-mount dome camera

5937

- **Viewing angle (HxVxD)**  
94 x 53 x 95°
- **IP65**
- **Size (WxHxD)**  
102 x 55 x 96 mm
- **3 year warranty**



#### Features

- High-definition picture quality
- Surface mount
- Heater
- Normal view
- Backlight compensation
- Automatic white balance
- Supports web browser access
- Fast setup feature in MDR 500 series to auto-assign camera IP address
- Picture Elements: 1920(H) x 1080(V)
- Imaging device: CMOS
- TV Lines: 700

#### Power

- Power consumption: 3.5 Watts
- Current: 0.3 Amps

#### Durability & Standards

- Mechanical vibration: 4.7G
- Mechanical shock: 51G
- Operating temperature: -40 to +70°C
- Video output signal: H.264 or H.265
- Network protocol: MDR5, ONVIF, TCP/IP, HTTP, DHCP, NTP, FTP
- CE marked
- E-Marked: UNECE R10 compliant
- FCC approved
- IC approved

**Note:** For use with MDR only

**Model**

**Part No:**

**NEW IP CAMERA**

**IP-1100C - Surface-mount camera**

**5936**



- **Viewing angle (HxVxD)**  
84 x 46 x 103°
- **IP67**
- **Size (WxHxD)**  
96 x 52 x 58mm
- **3 year warranty**



**Features**

- High-definition picture quality
- Surface mount
- Built-in G-sensor for automatic image orientation
- High power infrared LED for low-light performance
- Day/night sensor
- Normal view
- Backlight compensation
- Automatic white balance
- Supports web browser access
- Fast setup feature in MDR 500 series to auto-assign camera IP address
- Imaging device: CMOS
- Picture elements: 1920 x 1080
- TV Lines: 800

**Power**

- Power consumption: 5 Watts
- Current: 0.2 Amps

**Durability & Standards**

- Mechanical vibration: 8.5G
- Mechanical shock: 51G
- Operating temperature: -40 to +70°C
- Video output signal: H264 or H.265
- Network protocol: MDR5, ONVIF, TCP/IP, HTTP, DHCP, NTP, FTP
- CE marked
- E-Marked: UNECE R10 compliant
- FCC approved
- IC approved

**Note:** For use with MDR only

**NEW IP EXPANSION MODULES**

**IP-EM4 - PON 4-channel switch**

**5860**

**IP-EM8 - PON 8-channel switch**

**5861**



- **12-24Vdc**
- **4 or 8 IP camera inputs**
- **Size (WxHxD)**  
IP-EM4: 149 x 44 x 127mm  
IP-EM8: 174 x 54 x 129.5mm
- **3 year warranty**

**Features**

- Expands the channel capability of the MDR by enabling the addition of IP cameras:
- IP-EM4 - adds 2 channels to MDR-504
- IP-EM4 - adds 4 channels to MDR-508
- IP-EM8 - adds 8 channels to MDR-508
- IP-EM8 not compatible with MDR-504

**Power**

- Power consumption: 3 Watts

**Durability & Standards**

- Mechanical vibration: 2.3G
- Mechanical shock: 150G
- Operating temperature: -40 to +70°C
- CE marked
- E-Marked: UNECE R10 compliant
- FCC approved
- IC approved

**NEW IP CAMERA ACCESSORIES**

**IP-EC-1 - CAT5E Ethernet cable 1 metre**

**5865**

**IP-EC-5 - CAT5E Ethernet cable 5 metre**

**5866**

**IP-EM-PC - MDR-PON Power cable**

**5864**

**IP-L601 - IP Camera extension cable 1 metre**

**5867**

**IP-L603 - IP Camera extension cable 3 metre**

**5902**

**IP-L605 - IP Camera extension cable 5 metre**

**5903**

**IP-L610 - IP Camera extension cable 10 metre**

**5982**

**IP-L615 - IP Camera extension cable 15 metre**

**5904**

**IP-L620 - IP Camera extension cable 20 metre**

**5983**

**IP-L630 - IP Camera extension cable 30 metre**

**5984**

**IP-1XXX-PC - IP Power and Ethernet cable -**

**5985**

To connect a single camera to an MDR without the PON Switch



**WARNING:** There is a latency (time lag) in all digital video transmission, including IP Cameras. Although this time lag is small (~800ms), it is unacceptable for a camera that a driver is using as a safety and manoeuvring aid. Brigade IP cameras are an excellent choice for general monitoring (eg bus interior, doors, luggage compartment) and recording purposes, but should not be used as a driver aid for manoeuvring or blind-spot monitoring. Analogue cameras are still the best choice for safety critical manoeuvring and blind spot monitoring applications



# Ultrasonic Object Detection Systems

## Sensor Systems

Reducing blind spots and improving driver visibility are important issues for operators of road-going vehicles. Brigade's ultrasonic detection sensors minimise both vehicle damage and collisions with pedestrians, cyclists or objects. Perfect for road-going commercial vehicles operating in confined spaces or manoeuvring at low speed.

The detection system alerts the driver of objects close to the vehicle, whether moving or stationary. An in-cab warning informs of distance whilst an optional external speaking alarm can be added to alert cyclists and pedestrians that the vehicle is turning.

## On-Screen Display

Working in conjunction with a camera monitor system and up to two ultrasonic detection systems, the on-screen display module warns the driver of obstacles close to the vehicle by overlaying 3-stage audible and visual ultrasonic data onto the camera image on the vehicle's monitor.

- **Integration of Brigade's ultrasonic obstacle detection systems and camera monitor systems**
- **Ultrasonic detection warnings overlaid onto camera image on in-cab monitor**
- **Reduced driver stress and distractions as all information is in one view**

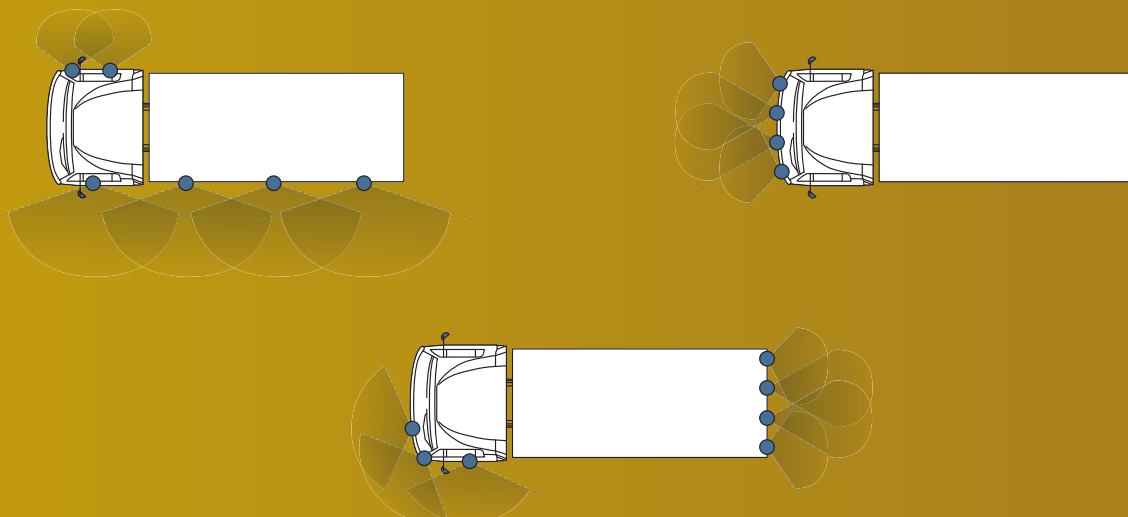

## Ultrasonic Detection On-Screen Display Module



- Integration of Brigade's ultrasonic obstacle detection systems and Backeye® camera monitor systems
- Ultrasonic detection warnings overlaid onto camera image on in-cab monitor
- Reduced driver stress and distractions as all information is in one view

### Sensor data and camera image combined

Brigade's ultrasonic proximity sensors minimise both vehicle damage and collisions with pedestrians, cyclists or objects. Perfect for road-going commercial vehicles operating in confined spaces or manoeuvring at low speed.

Working in conjunction with a Backeye® camera monitor system and up to two ultrasonic detection systems, the on-screen display module warns the driver of obstacles close to the vehicle by overlaying 3-stage audible and visual ultrasonic data onto the camera image on the monitor.

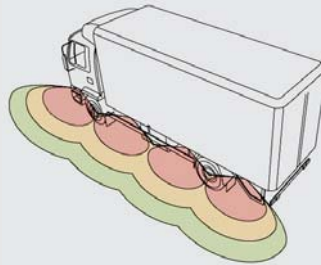

**Model**

**Part No:**

### ULTRASONIC ON-SCREEN DISPLAY MODULE

UDS-OSD20-ECU - On-screen display module PAL

5099

UDS-OSD21-ECU - On-screen display module NTSC

5347



• Allows 3-stage audible and visual Ultrasonic data to be overlaid onto camera image on vehicle monitor

- 12-24Vdc
- 2 camera inputs
- 2 trigger inputs
- 2 UDS inputs
- 2 UDS outputs
- 2 year warranty

#### Contents

- OSD ECU
- Power cable
- Splitter cable
- Trigger cable

#### Features

- Overlay on monitor of vehicle icon and detection data from up to 2 x ultrasonic detection systems
- Compatible with 1x Sidescan® Frontscan® and Backscan®
- UDS overlay will appear on a black background if no cameras installed
- Graphics can be overlaid left or right on the monitor
- Audible warning via monitor
- Ultrasonic system fault displayed on monitor
- Compatible with MDR

#### Durability & Standards

- Mechanical vibration: 5G
- Mechanical shock: 10G
- Operating temperature: -30 to +70°C +22 to +158°F
- IP30
- Dimensions: 74 x 118 x 28 mm (WxDxH) 2.9 x 4.6 x 1.1"
- CE marked
- E-Marked: UNECE R10 compliant
- FCC Approved
- IC Approved

#### Power

- Power consumption: 1.7 Watts
- Current: 140mA

**Note: Not compatible with HD camera monitor systems**



**Model**

**Part No:**

**BACKSCAN® ULTRASONIC DETECTION SYSTEM**

**BS-4000W - Backscan® Rear reversing sensor system**

**3744**



- 4 sensor system
- 12-24Vdc
- 2.5m detection range - outer sensors 2.5m/0.6m (selectable via dip switch)
- Graduated visual and audible distance warning display
- Underslung and flush-mount fixings included
- 50cm compensation range for sensors fitted inboard of vehicle rear (selectable via dip switch)
- 3 year warranty

**Contents**

- 4 x sensors
- Visual and audible display
- 4 x 0° flush mount fixings
- 4 x 11° flush mount fixings
- 4 x underslung fixings
- Waterproof control box
- 15m display cable
- 4 x 2.5m sensor cables

**Features**

- Obstacles detected in under 200 milliseconds
- Environment Learning Mode prevents false alarms from tow-hooks and other ancillary equipment that intrudes in the first 100cm of the detection zone
- Self-diagnostic function
- 1 x Trigger output

**Durability & Standards**

- Mechanical vibration: 5G
- Mechanical shock: 10G
- Operating temperature: -30 to +80°C
- Waterproof sensors to IP68
- Waterproof control box to IP69K
- CE marked
- E-Marked: UNECE R10 compliant
- FCC approved

**Power**

- Power consumption: 2.4 Watts
- Current: 200mA



**ADDITIONS FOR ARTICULATED VEHICLES**

<b>SK-15-04</b>	<b>Truck/trailer camera/sensor cable kit</b>	<b>3997</b>
<b>SK-UDS-05</b>	<b>Truck/trailer sensor only cable kit</b>	<b>4219</b>
<b>UDS-10BC</b>	<b>10m Buzzer/display cable</b>	<b>3716</b>

**OPTIONAL EXTRA**

<b>UDS-RELAY-24</b>	<b>Trigger-out diode protected relay 24Vdc</b>	<b>4215</b>
<b>UDS-RELAY-12</b>	<b>Trigger-out diode protected relay 12Vdc</b>	<b>4216</b>

To power a device switched by the output trigger

# Ultrasonic Object Detection

## Sidescan®Flex

### Flexible side detection

Sidescan®Flex is a four-sensor system fitted to the side of a vehicle to detect objects in the nearside blind spot, where cyclists or pedestrians can otherwise go undetected.

An advancement to the standard Sidescan® system, Sidescan®Flex allows the operator to choose from four detection configurations, each with different detection distances and audible and visual alerts (see table).

Sidescan® Flex has an increased maximum detection range of 2.5 metres.

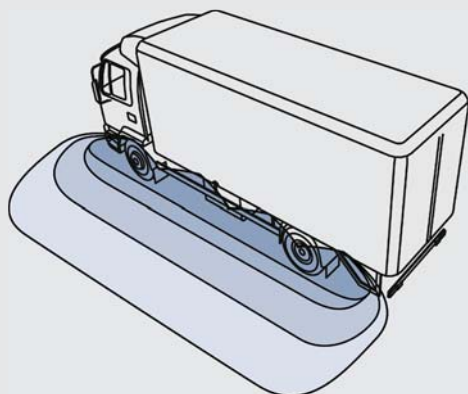

Detection distance		Config 1	Config 2	Config 3	Config 4
0 - 0.6m	Beeps per second	Constant	Constant	Constant	Constant
	Flashes per second	8	8	8	8
0.6 - 0.9m	Beeps per second	Constant	4	4	4
	Flashes per second	8	8	8	8
0.9 - 1.5m	Beeps per second	4	-	-	1
	Flashes per second	4	4	4	4
1.5 - 2.5m	Beeps per second	1	-	-	-
	Flashes per second	1	1	-	-

**Model**

**Part No:**

**NEW**

## SIDESCAN®FLEX ULTRASONIC DETECTION SYSTEM

<b>SS-4200W -</b>	<b>Sidescan®Flex sensor system with mute function</b>	<b>5916</b>
<b>SS-4200W-000 -</b>	<b>Sidescan®Flex sensor system with mute function, low speed trigger module and turn indicator sensor kit</b>	<b>6075</b>

Includes LS-60-A low speed trigger module and TS-001ECU turn indicator sensor



- 4 sensor system
- 12-24Vdc
- Detection zones - 0 - 2.5m (4 audible/visual configurations, selectable via dip switches)
- Underslung and flush-mount fixings included
- 1 Output trigger
- 3 year warranty

#### Contents

- 4 x sensors
- Buzzer
- 4 x 0° flush mount fixings
- 4 x 11° flush mount fixings
- 4 x underslung fixings
- Waterproof control box
- 10m buzzer cable
- 4 x 4.5m sensor cables
- 2 x 2.5m extension cables

#### Features

- Obstacles detected in under 200 milliseconds
- Buzzer with audible distance warning, LED & adjustable volume control
- Buzzer will silence after 4 seconds if there is no movement from detected object or vehicle
- Self-diagnostic function

- Environment Learning Mode prevents false alarms from ancillary equipment that intrudes in the first 100cm of the detection zone

#### Durability & Standards

- Mechanical vibration: 5G
- Mechanical shock: 10G
- Operating temperature: -30 to +80°C
- Waterproof sensors to IP68
- Waterproof control box to IP69K
- CE marked
- E-Marked: UNECE R10 compliant
- FCC approved

#### Power

- Power consumption: 2.4 Watts
- Current: 200mA

### OPTIONAL EXTRA



<b>UDS-RELAY-24</b>	<b>Trigger-out diode protected relay 24Vdc</b>	<b>4215</b>
<b>UDS-RELAY-12</b>	<b>Trigger-out diode protected relay 12Vdc</b>	<b>4216</b>

To power a device switched by the output trigger

**Model**

**Part No:**

**SIDESCAN® ULTRASONIC DETECTION SYSTEM**

<b>SS-4100W -</b>	<b>Sidescan® Side sensor system with mute function</b>	<b>5257</b>
<b>SS-4100W-000 -</b>	<b>Sidescan® Side sensor system with mute function, low speed trigger module and turn indicator sensor kit</b>	<b>5344</b>

Includes LS-60-A low speed trigger module and TS-001ECU turn indicator sensor



- 4 sensor system
- 12-24Vdc
- 1.0/1.5m detection range - (selectable via dip switch)
- Audible distance warning
- Underslung and flush-mount fixings included
- 2 levels of sensitivity - (selectable via dip switch)
- 3 year warranty

- Contents**
- 4 x sensors
  - Buzzer
  - 4 x 0° flush mount fixings
  - 4 x 11° flush mount fixings
  - 4 x underslung fixings
  - Waterproof control box
  - 10m buzzer cable
  - 4 x 4.5m sensor cables
  - 2 x 2.5m extension cables
- Features**
- Obstacles detected in under 200 milliseconds
  - Buzzer with audible distance warning, LED & adjustable volume control
  - Buzzer will silence after 4 seconds if there is no movement from detected object or vehicle
  - Environment Learning Mode prevents false alarms from ancillary equipment that intrudes in the first 100cm of the detection zone
  - Self-diagnostic function
- Durability & Standards**
- Mechanical vibration: 5G
  - Mechanical shock: 10G
  - Operating temperature: -30 to +80°C
  - Waterproof sensors to IP68
  - Waterproof control box to IP69K
  - CE marked
  - E-Marked: UNECE R10 compliant
  - FCC approved
- Power**
- Power consumption: 2.4 Watts
  - Current: 200mA



**SIDESCAN®/SIDESCAN®FLEX ADDITIONS FOR ARTICULATED VEHICLES**

<b>SK-15-04</b>	<b>Truck/trailer camera/sensor cable kit</b>	<b>3997</b>
<b>SK-UDS-05</b>	<b>Truck/trailer sensor only cable kit (required)</b>	<b>4219</b>
<b>UDS-10BC</b>	<b>10m display cable (required)</b>	<b>3716</b>
<b>SS-4100W</b>	<b>Additional Sidescan sensor system for cab (optional)</b>	<b>5257</b>

**SIDESCAN®/SIDESCAN®FLEX RECOMMENDED EXTRAS**

<b>LS-60-A</b>	<b>Low speed trigger module</b> <small>Enables sensors below designated speed</small>	<b>4851</b>
<b>TS-001ECU</b>	<b>Turn indicator trigger for system activation</b>	<b>1362</b>

**SIDESCAN®/SIDESCAN®FLEX OPTIONAL EXTRA**

<b>SS-BC-08</b>	<b>Backchat speaking alarm with side turn warning for cyclists/pedestrians</b> <small>Note: TS-001ECU Turn indicator trigger is required</small>	<b>1334</b>
<b>TCO-47-01</b>	<b>Latched auto-reset Backalarm cut-out (dash mount)</b>	<b>4752</b>

# Ultrasonic Object Detection

**Model**

**Part No:**

## FRONTSCAN® ULTRASONIC DETECTION SYSTEM

**FS-4000W - Frontscan® Front sensor system**

**3747**



- 4 sensor system
- 12-24Vdc
- 2.0m/1.0m detection range - outer sensors can be reduced to 0.6m (selectable via dip switches)
- Audible distance warning
- Flush-mount
- 3 year warranty

**Contents**

- 4 x sensors
- Buzzer
- 4 x 11° flush mount fixings
- 4 x 18° flush mount fixings
- 4 x 26° flush mount fixings
- Waterproof control box
- 2.5m buzzer cable
- 4 x 2.5m sensor cables

**Features**

- Obstacles detected in under 200 milliseconds
- Environment Learning Mode prevents false alarms from tow-hooks and other ancillary equipment that intrudes in the first 100cm of

- the detection zone
- Self-diagnostic function
- 1 x Trigger output

**Durability & Standards**

- Operating temperature: -30 to +80°C
- Waterproof sensors to IP68
- Waterproof control box to IP69K
- CE marked
- E-Marked: UNECE R10 compliant

**Power**

- Power consumption: 2.4 Watts
- Current: 200mA

### RECOMMENDED EXTRA



**LS-60-A**

**Low speed trigger module**

Enables sensors below designated speed

**4851**

### OPTIONAL EXTRA



**UDS-RELAY-24**

**Trigger-out diode protected relay 24Vdc**

**4215**

**UDS-RELAY-12**

**Trigger-out diode protected relay 12Vdc**

**4216**

To power a device switched by the output trigger

## CORNERSCAN® ULTRASONIC DETECTION SYSTEM

**CS-3100 - Cornerscan® Corner sensor system with mute function**

**5261**



- 3 sensor system
- 12-24Vdc
- 0.6/1.0m detection range - (selectable via dip switch)
- Audible distance warning
- Flush-mount
- 2 levels of sensitivity - (selectable via dip switch)
- 3 year warranty

**Contents**

- 3 x sensors
- Buzzer
- 3 x 11° flush mount fixings
- 3 x 18° flush mount fixings
- 3 x 26° flush mount fixings
- Waterproof control box
- 2.5m buzzer cable
- 3 x 2.5m sensor cables

**Features**

- Obstacles detected in under 200 milliseconds
- Buzzer with audible distance warning, LED & adjustable volume control
- Buzzer will silence after 4 seconds if there is no movement from detected object or vehicle
- Environment Learning Mode prevents false alarms

- from ancillary equipment within the first 100cm of the detection zone
- Self-diagnostic function

**Durability & Standards**

- Mechanical vibration: 5G
- Mechanical shock: 10G
- Operating temperature: -30 to +80°C
- Waterproof sensors to IP68
- Waterproof control box to IP69K
- CE marked
- E-Marked: UNECE R10 compliant
- FCC approved

**Power**

- Power consumption: 2.4 Watts
- Current: 2 Amps

### RECOMMENDED EXTRA



**LS-60-A**

**Low speed trigger module**

Enables sensors below designated speed

**4851**

**Model**

**Part No:**

**STEPSCAN™ ULTRASONIC DETECTION SYSTEM**

<b>ST-2100 -</b>	<b>Stepscan™ Step sensor system with mute function</b>	<b>5262</b>
<b>ST-2100-60-A -</b>	<b>Stepscan™ Step sensor system with mute function and low speed trigger module</b>	<b>5345</b>
	<small>Includes UDS-4.5SC 4.5m extension cable</small>	



- **2 sensor system**
- **12-24Vdc**
- **0.6/1.0m detection range - (selectable via dip switch)**
- **Audible distance warning**
- **Flush-mount**
- **2 levels of sensitivity - (selectable via dip switch)**
- **3 year warranty**

- Contents**
- 2 x sensors
  - Buzzer
  - 2 x 11° flush mount fixings
  - 2 x 18° flush mount fixings
  - 2 x 26° flush mount fixings
  - Waterproof control box
  - 2.5m buzzer cable
  - 2 x 2.5m sensor cables
- ancillary equipment that intrudes in the first 100cm of the detection zone**
- Self-diagnostic function
- Durability & Standards**
- Mechanical vibration: 5G
  - Mechanical shock: 10G
  - Operating temperature: -30 to +80°C
  - Waterproof sensors to IP68
  - Waterproof control box to IP69K
  - CE marked
  - E-Marked: UNECE R10 compliant
  - FCC approved
- Power**
- Power consumption: 2.4 Watts
  - Current: 200mA

- Features**
- Obstacles detected in under 200 milliseconds
  - Buzzer with audible distance warning, LED & adjustable volume control
  - Buzzer will silence after 4 seconds if there is no movement from detected object or vehicle
  - Environment Learning Mode prevents false alarms from



**RECOMMENDED EXTRA**

<b>LS-60-A</b>	<b>Low speed trigger module</b> <small>Enables sensors below designated speed</small>	<b>4851</b>
----------------	--	-------------

**EXTENSION CABLES**



<b>UDS-2.5BC -</b>	<b>Buzzer/display extension cable 2.5m</b>	<b>3717</b>
<b>UDS-10BC -</b>	<b>Buzzer/display extension cable 10m</b>	<b>3716</b>
<b>UDS-15BC -</b>	<b>Buzzer/display extension cable 15m</b>	<b>3746</b>
<b>UDS-2.5SC -</b>	<b>Sensor extension cable 2.5m</b>	<b>3719</b>
<b>UDS-4.5SC -</b>	<b>Sensor extension cable 4.5m</b>	<b>3720</b>
<b>UDS-7.0SC -</b>	<b>Sensor extension cable 7.0m</b>	<b>5623</b>



# Backsense®

## Radar Object Detection Systems

### FMCW technology

Backsense® heavy-duty radar sensor systems are designed for heavy-duty machines to detect people and objects in blind spots. They detect stationary and moving objects, providing the driver with in-cab visual and audible warnings – alerting the operator whose attention cannot be focused on all danger areas.

Backsense® radar uses Frequency Modulated Continuous Wave (FMCW) technology, transmitting a continuously varying radar frequency signal with unique time stamps to each instance of the wave. The time of the returning wave is referenced to the stamp without the radar needing to pause transmitting. This gives more accurate detection than alternative radar products using Pulsed Radar technology that transmit a burst of radar and listen for the returning wave.

### Radar Models

- **Backsense®** systems are available with fixed and programmable detection ranges and a programmable model with an IP69K in-cab display. Bespoke detection areas can be programmed to calibrate-out fixed objects or bodywork.
- **Backsense® Network radar** allows you to link up to eight radar sensors. The system provides object detection in CAN message format which may be processed to display data on control panels/ displays on the vehicle or used to control aspects of the machine.
- **Backsense® on-screen display** works in conjunction with Backeye® camera monitor systems and up to two radar sensors. It warns the driver of objects in the danger zone by overlaying 5-stage audible and visual radar data onto the camera image on the monitor.

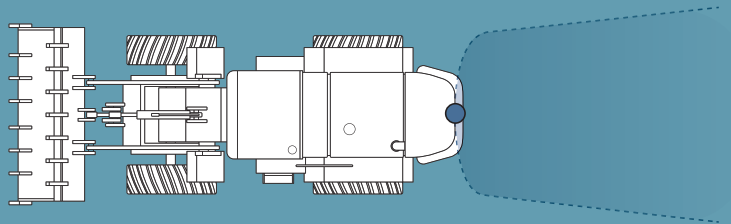

# Backsense® Radar Object Detection

Model

Part No:

## NEW IP69K PROGRAMMABLE BACKSENSE® OBJECT DETECTION SYSTEM

BS-9000-WD - Waterproof display - Programmable detection range

5713



- 9-32Vdc
- **Detection length: up to 30m (minimum programmable distance 0-3m)**
- **Detection width: 2m to 10m**
- **Rugged design for harsh environmental conditions**
- **Sensor size (WxHxD) 217 x 129 x 50mm**
- **Display size without bracket (WxHxD) 118 x 97 x 55 mm**
- **IP69K sensor**
- **IP69K display**
- **3 year warranty**

### Contents

- 1 x BS-9000 Radar sensor
- 1 x IP69K audible and visual display with mounting bracket
- 1 x 9m extension cable
- 1 x Network Y Cable
- 1 x Network terminator
- 1 x Mini USB cable

### Features

- Frequency modulated continuous wave (FMCW) radar technology
- Effectively detects stationary, moving and multiple objects
- 1 activation input
- 1 trigger output
- 2nd trigger output for optional external alarm
- Programmable:
  - Detection area
  - Blind zones - system ignores fixed objects
  - Trigger activation
  - Buzzer
- 5 stage audible and visual distance warning display

- 3 set volume levels (maximum 95dB) with volume lock
- AMPS hole pattern for alternative mounting with industry-standard bracket
- Resistant to water, moisture, dust, vibration, heat, cold, mud and glare

### Power

- Current: 0.9 Amps
- Power consumption: 8 Watts

### Durability & Standards

- Mechanical shock- sensor: 100G
- Mechanical shock- display: 50G
- Mechanical vibration: 8.3G
- Operating temperature: -40 to +85°C
- CE marked
- E-Marked: UNECE R10 compliant
- BS EN 13309: 2010
- ISO13766: 2006

### Configuration Software

- \*Available via Brigade website or USB (purchased separately)

## OPTIONAL EXTRAS

CT-470 - Constant tone external alarm - 102dB

1346

\*BS-WD-USB - USB -programming software, port driver and operating guide

5637

## PROGRAMMABLE BACKSENSE® OBJECT DETECTION SYSTEM

BS-8000 - Standard display - Programmable detection range

4530



- 9-32Vdc
- **Detection length: up to 30m (minimum programmable distance 0-3m)**
- **Detection width: 2 to 10m**
- **Rugged design for harsh environmental conditions**
- **Sensor size (WxHxD) 217 x 129 x 50mm**
- **Display size with bracket 101 x 71 x 70mm (WxHxD)**
- **IP69K sensor**
- **3 year warranty**

### Contents

- 1 x Configurable radar sensor
- 1 x Audible and visual display with USB socket and mounting bracket
- 1 x 9m extension cable
- 1 x Mini USB cable
- 1 x Software CD

### Features

- Frequency modulated continuous wave (FMCW) radar technology
- Effectively detects stationary, moving and multiple objects
- 1 activation input
- 1 trigger output
- Programmable:
  - Detection area
  - Blind zones - system ignores fixed objects
  - Trigger activation
  - Buzzer

- 5 stage adjustable audible and visual distance warning display
- Sensor resistant to water, moisture, dust, vibration, heat, cold, mud and glare

### Power

- Current: 0.8 Amps
- Power consumption: 8 Watts

### Durability & Standards

- Mechanical shock: 100G
- Mechanical vibration: 8.3G
- Operating temperature: -40 to +85°C
- CE marked
- E-Marked: UNECE R10 compliant
- BS EN 13309: 2010
- ISO13766: 2006



**Model**

**Part No:**

**FIXED BACKSENSE® OBJECT DETECTION SYSTEMS**



<b>BS-7030 - Standard display - 3m length x 2.5m width detection range</b>	<b>4527</b>
<b>BS-7045 - Standard display - 4.5m length x 3.5m width detection range</b>	<b>4528</b>
<b>BS-7060 - Standard display - 6m length x 4.5m width detection range</b>	<b>4529</b>

- 9-32Vdc
- Maximum detection range of either 3m, 4.5m or 6m
- Rugged design for harsh environmental conditions
- Sensor size (WxHxD)  
217 x 129 x 50mm
- Display size with bracket  
101 x 71 x 70mm (WxHxD)
- IP69K sensor
- 3 year warranty

**Contents**

- 1 x Non-configurable radar sensor
- 1 x Standard audible and visual display with mounting bracket
- 1 x 9m extension cable

**Features**

- Frequency modulated continuous wave (FMCW) radar technology
- Effectively detects stationary, moving and multiple objects
- 1 activation input
- 1 trigger output
- 5 stage adjustable audible and visual distance warning display
- Sensor resistant to water, moisture, dust, vibration, heat, cold, mud and glare

**Power**

- Current: 0.8 Amps
- Power consumption: 8 Watts

**Durability & Standards**

- Mechanical shock: 100G
- Mechanical vibration: 8.3G
- Operating temperature: -40 to +85°C
- CE marked
- E-Marked: UNECE R10 compliant
- BS EN 13309: 2010
- ISO13766: 2006

**BACKSENSE® RADAR OBJECT DETECTION ACCESSORIES**



<b>BS-02DCX - 2m extension cable</b>	<b>5272</b>
<b>BS-05DCX - 5m extension cable</b>	<b>4550</b>
<b>BS-09DCX - 9m extension cable</b>	<b>4551</b>
<b>BS-25DCSX - 25m extension cable (Female end connector supplied loose)</b>	<b>4975</b>
<b>BS-00NYC - Network Y Cable for 9000 series radar</b>	<b>5270</b>
<b>BS-02PIC - Network power input cable for 9000 series radar</b>	<b>5271</b>
<b>BS-00NT - 120 Ohms Network Terminator for 9000 series radar</b>	<b>5291</b>
<b>BKT-017 - Adjustable radar bracket</b> with 105mm depth bracket mounting arms	<b>4676</b>
<b>BKT-018 - Low-profile adjustable radar bracket</b>	<b>4758</b>

# Backsense® Radar Object Detection

## Backsense® Radar On-Screen Display

- Integration of Brigade's Backsense® radar detection and Backeye® camera monitor systems
- Up to 2 Radar detection warnings overlaid onto camera image on in-cab monitor
- Reduced driver stress and distractions as all information is in one place



### Radar sensor data and camera image combined

Working in conjunction with a Backeye® camera monitor system and up to two Backsense® Network radar detection systems, the on-screen display module warns the driver of obstacles in the danger zone by overlaying 5-stage audible and visual radar data onto the camera image on the monitor.

**Model**

**Part No:**

## BACKSENSE® RADAR ON-SCREEN DISPLAY KIT

**BS-9001-OSD - Radar sensor & On-screen display module**

**5658**



- Allows 5-stage audible and visual radar data to be overlaid onto camera images on in-cab monitor
- 12-24Vdc
- Detection length: up to 30m (minimum programmable distance 3m)
- Detection width: 2 to 10m
- Sensor size (WxHxD) 217 x 129 x 50mm
- OSD ECU size (WxHxD) 195 x 120 x 35mm
- 2 camera inputs
- 2 BS-9000 Backsense® inputs
- 3 trigger inputs
- 3 trigger outputs
- 3 year warranty

### Contents

- 1 x OSD Radar ECU
- 1 x BS-9000 Radar sensor
- 1 x Network power cable
- 1 x Extension cable 9m
- 3 x Network Y-cable
- 2 x Network terminator

### Features

- Frequency modulated continuous wave (FMCW) radar technology
- Overlay on monitor of detection data from up to 2 BS-9000 radar sensors
- Each radar can be shown in one of 8 positions around the monitor/vehicle
- Compatible with Backsense® BS-9000 Network radar sensors only
- Programmable:
  - Detection area
  - Blind zones - system ignores fixed objects
  - Overlay transparency level
- Radar system fault displayed on monitor
- USB connection for configuration via PC
- Compatible with MDR, non-HD Backeye®360 & Elite range camera monitor systems (Select range via adapters)
- Audible warning via monitor or optional internal buzzer
- Supports external warning alarm

### Durability & Standards

- Operating temperature: -40 to +85°C
- OSD: IP30
- CE marked
- E-Marked: UNECE R10 compliant
- FCC Approved
- IC Approved

### Configuration Software

- \*Available via Brigade website or USB (purchased separately)

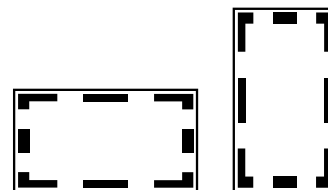

To not obstruct camera views, each radar can be shown in one of eight positions around the edge of the monitor

Camera monitor system not included

## TO ADD AN ADDITIONAL RADAR SENSOR:

1 x BS-9000 - Network Radar sensor	5266
1 x BS-00NYC - Network Y Cable	5270
1 x Extension cable	

## OPTIONAL EXTRAS

*BS-9001-USB- USB -programming software, port driver and operating guide	5656
AC-007 - Adapter cable to connect a Select range monitor	1984
AC-020 - Adapter cable to connect a Select range camera	2590

## Backsense® CAN Radar

For OEM and specialist application markets, Brigade's Network Radar allows you to connect and link up to 8 sensors to cover large, sometimes complex blind spot zones around a vehicle or machine.

The system provides object detection in CAN (Controller Area Network) message format which may be processed to display data on control panels/displays on the vehicle or used to interact with aspects of the machine.

Each connected radar sensor is allocated a unique ID and will transmit data for up to 8 closest objects. With a detection range of up to 30m length and 10m width, it provides a flexible system to meet customer specific requirements.

- Provides object detection in CAN message format
- Independent CAN Bus may communicate with existing CAN network via CAN Gateway
- Separate CAN message & ID for each object detected (up to 8 per sensor)

### NETWORK BACKSENSE® OBJECT DETECTION

#### BS-9000 - Backsense® CAN object detection radar

**5266**

- 12-24 Vdc
- Detection length: up to 30m
- Detection width: up to 10m
- Sensor size (WxHxD) 217 x 129 x 50mm
- IP69K sensor
- 3 year warranty

**Contents**

- 1 x BS-9000 Radar sensor

**Features**

- Frequency modulated continuous wave (FMCW) radar technology
- Network up to 8 sensors
- Extremely rugged design for severe weather conditions and all terrains
- Communication via CAN Gateway
- Configurable CAN ID
- Complies with CAN2.0A Base Frame Format
- Separate CAN message & ID for each object detected (up to 8 closest objects per sensor)

**Power**

- Current: 0.4 Amps
- Power consumption: 4 Watts

**Durability & Standards**

- Mechanical shock: 100G
- Operating temperature: -40 to +85°C
- CE marked
- E-Marked: UNECE R10 compliant
- BS EN 13309: 2010
- ISO13766: 2006

**Note: For CAN message format, refer to user manual at [brigade-electronics.com](http://brigade-electronics.com)**



# Warning Alarms & Quiet Vehicle Sounder

## Warning and Reversing Alarms

Vital safety devices needed to warn workers and pedestrians that a vehicle is manoeuvring.

**bbs-tek® white sound®** are the safest alarms in the world due to their instant locatability and directional sound. The multi-frequency alarms are only heard in the danger zone, thus eliminating noise nuisance for local residents. **bbs-tek®** alarms are endorsed by PIEK and the Noise Abatement Society and have been awarded the Quiet Mark.



**bbs-tek® white sound® Smart alarms** auto-adjust to 5-10dB above ambient.

### Heavy duty

For plant, quarry and construction machines or environments with high ambient noise.

### Medium duty

Ideal for commercial road going vehicles and environments with mid-level ambient noise.

## Quiet Vehicle Sounder

Designed for electric and hybrid-electric vehicles of all types, the QVS Electric Vehicle Sounder warns pedestrians and other vulnerable road users that a quiet vehicle is approaching.

Front speaker system incorporating **bbs-tek®** patented technology for instantly locatable and directional sound. Pitch and volume increase with vehicle speed in a similar way as an internal combustion engine. Sound cuts out above a pre-set speed threshold.



# bbs-tek® White Sound® Alarms

**Model**

**Part No:**

## WHITE SOUND® SMART REVERSING ALARM



**SA-BBS-107 - Self-adjusting heavy-duty - 87-107 Decibels**

**1400**

- 12-24Vdc
- IP68
- Size (WxHxD)  
172 x 79 x 95mm
- Lifetime warranty

**Features**

- Alarm continually adjusts to 5-10dB above ambient
- Multi-frequency broadband sound
- Instantly locatable
- Sound confined to danger area
- Eliminates noise nuisance
- Sounder unit: Driver
- Hole centres (mm): 153

**Power**

- Current: Max 1 Amp

**Durability & standards**

- Mechanical vibration: 10G
- Operating temperature: -40 to +85°C
- CE marked
- E-Marked: UNECE R10 compliant
- SAE J994

## WHITE SOUND® SMART REVERSING ALARM



**SA-BBS-97 - Self adjusting - medium duty - 77-97 Decibels**

**1399**

**SA-BBS-97HV - Self adjusting - electric forklift - 77-97 Decibels**

**1398**

- 12-24Vdc
- 36-80Vdc (HV)
- IP68
- Size (WxHxD)  
127 x 76 x 65mm
- Lifetime warranty

**Features**

- Alarm continually adjusts to 5-10dB above ambient
- Multi-frequency white sound alarm
- Instantly locatable
- Sound confined to danger area
- Eliminates noise nuisance
- Sounder unit: Driver
- Hole centres (mm): 98-108

**Power**

- Current: Max 1 Amp

**Durability & standards**

- Mechanical vibration: 10G
- Operating temperature: -40 to +85°C
- CE marked
- E-Marked: UNECE R10 compliant
- SAE J994
- NAS/PIEK approved for night-time delivery

## WHITE SOUND® REVERSING ALARM



**BBS-107 - Heavy duty - 107 Decibels**

**0899**

**BBS-102 - Heavy duty - 102 Decibels**

**0898**

- 12-24Vdc
- IP68
- Size (WxHxD)  
172 x 79 x 95mm
- Lifetime warranty

**Features**

- Multi-frequency broadband sound
- Instantly locatable
- Sound confined to danger area
- Eliminates noise nuisance
- Sounder unit: Driver
- Hole centres (mm): 153

**Power**

- Current: Max 1 Amps

**Durability & standards**

- Mechanical vibration: 10G
- Operating temperature: -40 to +85°C
- CE marked
- E-Marked: UNECE R10 compliant
- SAE J994

## WHITE SOUND® REVERSING ALARM



ADR version



**BBS-82HV - Electric forklift - 82 Decibels**

**1322**

**BBS-92ADR - Petrol tanker - 92 Decibels**

**2165**

- 12-24Vdc
- 36-80Vdc (HV)
- IP68
- Size (WxHxD)  
127 x 76 x 65mm
- Lifetime warranty

**Features**

- Multi-frequency broadband sound
- Instantly locatable
- Sound confined to danger area
- Eliminates noise nuisance
- Sounder unit: Speaker
- Hole centres (mm): 98-108

**Power**

- Current: Max 0.3 Amps

**Durability & standards**

- Mechanical vibration: 10G
- Operating temperature: -40 to +85°C
- CE marked
- E-Marked: UNECE R10 compliant
- SAE J994

**Model**

**Part No:**

**WHITE SOUND® REVERSING ALARM**



<b>BBS-97 - Medium duty - 97 Decibels</b>	<b>0935</b>
<b>BBS-92 - Medium duty - 92 Decibels</b>	<b>0934</b>
<b>BBS-87 - Medium duty - 87 Decibels</b>	<b>0897</b>
<b>BBS-82 - Medium duty - 82 Decibels</b>	<b>0896</b>



noise abatement society



- 12-24Vdc
- IP68
- Size (WxHxD)  
105x65x37mm (BBS-97/92)  
105x65x32mm (BBS-87/82/77)
- Lifetime warranty

**Features**

- Multi-frequency broadband sound
- Instantly locatable
- Sound confined to danger area
- Eliminates noise nuisance
- Sounder unit: Speaker
- Hole centres (mm): 76

**Power**

- Current: Max 0.5 Amps

**Durability & standards**

- Mechanical vibration: 10G
- Operating temperature: -40 to +85°C
- CE marked
- E-Marked: UNECE R10 compliant
- SAE J994
- NAS/PIEK approved for night-time delivery (BBS-82 only)

**QVS QUIET VEHICLE SOUNDER (AVAS)**



<b>QVS-001-75 - Quiet Vehicle Sounder</b>	<b>5385</b>
---	-------------



- 12-24Vdc
- IP68 Speaker
- IP30 ECU
- Size Speaker (WxHxD)  
120 x 135 x 120mm
- Size ECU (WxHxD)  
93 x 26 x 185mm
- 2 year warranty



**Contents**

- 1 x Speaker
- 1 x ECU

**Features**

- Warns pedestrians and other VRU's that a quiet vehicle is approaching
- Combined multi-frequency bbs-tek® technology and tonal sounds
  - Multi-frequency sound
  - Directional and locatable - The sound is only heard in the hazard zone.
- Front speaker system
- Pitch and volume increase with vehicle speed to mimic an internal combustion engine
- Operational below speeds of 20MPH
- Front sounder operational when ignition activated (silenced when parking brake applied)
- Uses Tachograph speed signal\*\*
- Sounder unit: Speaker

**Power**

- Current: Max 0.1 Amps

**Durability & standards**

- Mechanical vibration: 10G
- Operating temperature: -30 to +70°C
- CE marked
- E-Marked: UNECE R10 compliant
- FCC approved
- IC Marked
- UNECE R138 compliant\*
- 49 CFR Part 571 and 585 Federal Motor Vehicle Safety Standards compliant\*

\* QVS helps achieve compliance for the vehicle.

\*\* If your vehicle is not equipped with a Tachograph, please contact us for alternative installation methods

**QVS Quiet Vehicle Sounder (AVAS)**

- Warns pedestrians and other vulnerable road users that a quiet vehicle is approaching.
- Incorporating bbs-tek® technology - Multi-frequency, directional and instantly locatable sound which is only heard in the hazard zone.
- Front speaker system.
- Pitch and volume increase with vehicle speed in a similar way as an internal combustion engine.

- Sound fades out above a pre-set speed threshold.
- Designed for electric and hybrid-electric vehicles of all types.



# Speaking Alarms

**Model**

**Part No:**

## NIGHTSHIFT® SPEAKING ALARM



**BC-01(NS) - Single reversing message - Nightshift - 90 or 0 Decibels**  
**BC-01(NS-B) - Bespoke single message - Nightshift - 90 or 0 Decibels**

**0378**  
**1198**

- 12-24Vdc
- IP68
- Size (WxHxD)  
122 x 84 x 50mm
- 2 year warranty

**Features**

- Real speech alarm
- \* BC-01 (NS) message "Ssh! Stand well clear, vehicle reversing..."
- Bespoke message up to 8 seconds, under 4 seconds for best speech quality
- Double engage reverse to cut-out or reduce sound
- Sounder unit: Speaker
- Hole centres (mm): 102

**Power**

- Current: 0.5 Amps

**Durability & standards**

- CE marked
- E-Marked: UNECE R10 compliant

## SPEAKING ALARM



**BC-01 - Single reversing message - 90 Decibels**  
**BC-01(B) - Bespoke single message - 90 Decibels**  
**BC-02(B) - Bespoke dual message - 90 Decibels**

**0077**  
**0079**  
**0083**

- 12-24Vdc
- IP68
- Size (WxHxD)  
122 x 84 x 50mm
- 2 year warranty

**Features**

- Real speech alarm
- \* BC-01 message "Ssh! Stand well clear, vehicle reversing..."
- Bespoke message up to 8 seconds, under 4 seconds for best speech quality
- Sounder unit: Speaker
- Hole centres (mm): 102

**Power**

- Current: 0.5 Amps

**Durability & standards**

- CE marked
- E-Marked: UNECE R10 compliant

## SPEAKING HANDBRAKE WARNING ALARM



2 wire version

**BC-01(H/Brake) - Single message - 2 wire - 90 Decibels**  
**BC-01(4W)(H/Brake) - Single message 4 wire - 90 Decibels**

**0849**  
**1715**

- 12-24Vdc
- IP68
- Size (WxHxD)  
122 x 84 x 50mm
- 2 year warranty

**Features**

- Real speech alarm
- \* Message "Bleep! Handbrake not applied..."
- Sounder unit: Speaker
- Hole centres (mm): 102

**Power**

- Current: 0.5 Amps

**Durability & standards**

- CE marked
- E-Marked: UNECE R10 compliant

## SPEAKING SIDE TURN WARNING ALARM



**SS-BC-08 - Single side-turn message - 90 Decibels**

**1334**

- 12-24Vdc
- IP68
- Size (WxHxD)  
122 x 84 x 50mm
- 2 year warranty

**Features**

- Real speech alarm
- \* Message "Ssh! Caution. Truck turning left..."
- Sounder unit: Speaker
- Hole centres (mm): 102

**Power**

- Current: 0.5 Amps

**Durability & standards**

- CE marked
- E-Marked: UNECE R10 compliant

Note: TS-001ECU Turn indicator trigger is required 1362



**Model**

**Part No:**

**VEHICLE INTERCOM**



**BC-VI - Normally open channel rear to cab; button press cab to rear**  
**BC-VI-2 - Normally closed channel; button press communication**

**0815**  
**0875**

- 12-24Vdc
- IP68
- Size (WxHxD)  
122 x 84 x 50mm
- 2 year warranty

**Features**

- Two-way communication system
- Master unit volume control: 80-95dB
- Includes master unit, slave unit and 25m cable
- Sounder unit: Speaker
- Hole centres (mm): 102

**Power**

- Current: 0.5 Amps

**Durability & standards**

- CE marked
- E-Marked: UNECE R10 compliant
- FCC Approved
- IC Approved

**ALARM ANCILLARIES**



**TCO-47 - Timed auto-reset reversing alarm cut-out (dash mount)**

**0663**

- 12-24Vdc
- 2 year warranty

**Features**

- Single touch timed relay
- Allows driver to cut-out alarm if reversing between the hours of 11.30pm-7.00am
- Auto-resets after 3-4 mins delay

**Durability and Standards**

- CE marked
- EMC approved

**ALARM ANCILLARIES**



**TCO-47-01 - Latched side-turn alarm cut-out (dash mount)**

**4752**

- 12-24Vdc
- 2 year warranty

**Features**

- Single touch timed relay
- Allows driver to cut-out alarm between the hours of 11.30pm-7.00am
- Resets by switch or ignition

**Durability and Standards**

- CE marked
- EMC approved

**ALARM ANCILLARIES**



**NS-2 - Nightshift reversing alarm cut-out switch**

**0334**

**NS-3 - Nightshift reversing alarm cut-out switch (auto gearbox)**

**0974**

- 12-24Vdc
- IP68
- 2 year warranty

**Features**

- Double engage reverse to cut-out alarm
- Resets when reverse gear disengaged
- No wiring necessary to cab

**Durability and Standards**

- CE marked
- EMC approved



# ZoneSafe®

## RFID Tag Detection System

### Keeping Workers Safe

ZoneSafe uses Radio Frequency Identification (RFID) technology to create detection zones around vehicles and mobile plant.

Vehicle-mounted antennas detect RFID tags which can be worn by workers, placed on objects or property, or set up around restricted areas. When a ZoneSafe tag enters a detection zone, the vehicle operator will automatically receive a visual and audible alert via the in-cab control unit which will enable them to take action as necessary. A vibrating tag will also warn a detected worker of an approaching vehicle.

ZoneSafe RFID technology does not require line-of-sight and tags will be detected regardless of obstructions, blind spots, adverse weather or poor visibility.

The ZoneSafe Smart Gateway can be set up to trigger alarms, open shutters or barriers etc. upon the detection of a ZoneSafe-equipped vehicle.

ZoneSafe RFID provides fast, reliable and accurate data exchange without any limitation on the number of tags or antennas in operation.

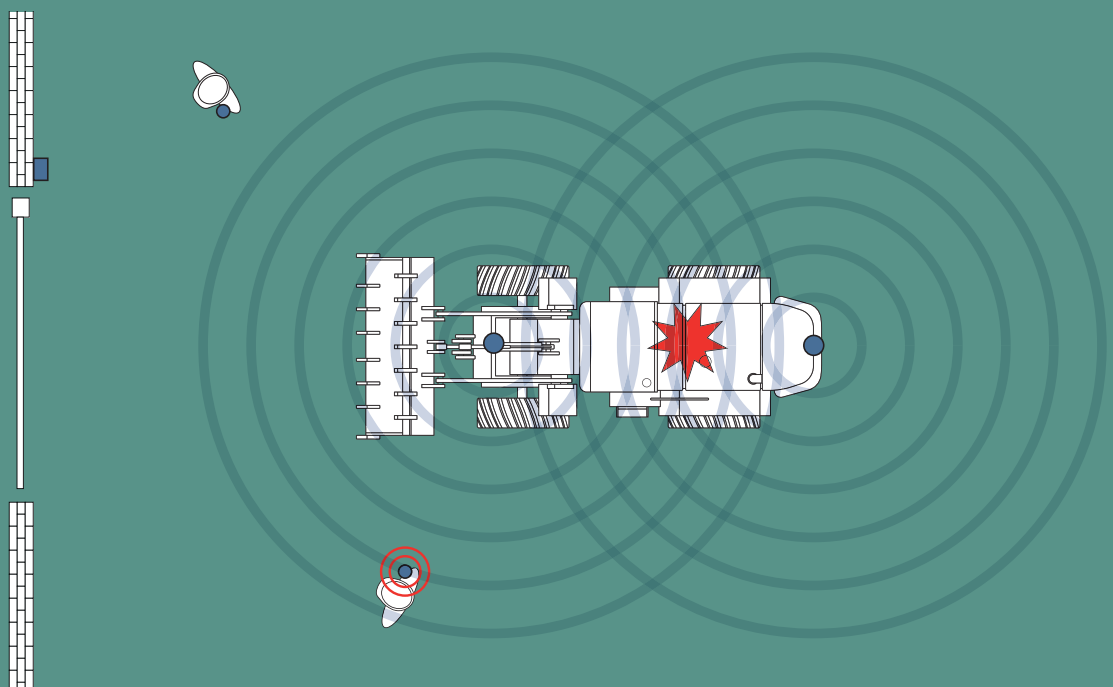

# Zonesafe® RFID Detection

## ZoneSafe Control Unit

The ZoneSafe Control Unit is installed in the cab so it is clearly visible to the driver. ZoneSafe is activated when a VibraTag Driver Tag is inserted into the Control Unit prior to operating the vehicle. Audible and visual alerts indicate various alarm states including a two-stage alert for the detection of one or more tags, system errors and the non-insertion of a driver tag. A mute button can override a detection alert once a tag has been acknowledged.

The Control Unit provides overall functionality of the system and acts as the driver interface. The unit contains an internal memory to store up to 4000 detected events and a WiFi interface for remote monitoring and downloads. Relays can be used for the addition of external sounders or beacons.

## ZoneSafe Antenna

A ZoneSafe Antenna creates a detection zone around a vehicle. Up to six antennas can be installed and linked in sequence to a control unit. The detection zone for each antenna can be programmed from smallest 3m up to largest 10m.

**Model**

**Part No:**

**NEW**

## ZONESAFE® RFID TAG DETECTION SYSTEM



**ZS-1000-ECU - ZoneSafe® Control Unit**

**5881**

- 12-24Vdc
- Size (WxHxD)  
102 x 180 x 58mm
- IP65
- WIFI configuration interface for remote monitoring and downloads
- 2 Year Warranty

### Features

- Installed in the cab of vehicle
- Two stage audible and visual warnings to the machine operator when a tag or tags are detected by connected antennas (available separately)
- Connect up to 6 antennas
- Internal memory to store up to 4,000 events
- System activation by inserting driver tag
- Alarm if driver tag is left in vehicle
- Central mute button to acknowledge the detection of one or more tags (configurable)

- Multi-colour status panel
- 3 selectable detection levels
- AMPS hole pattern mounting
- 1 x Trigger input
- 1 x Trigger output
- TX Frequency: 125kHz
- RX Frequency: 868.3MHz

### Power

- Current: 0.5 Amps

### Durability & Standards

- Operating temperature: -40 to +85C
- CE marked

## OPTIONAL EXTRA

**ZS-ECU-MP**

**Mounting Plate for Control Unit**

**5900**

**NEW**

## ZONESAFE® RFID TAG DETECTION SYSTEM



**ZS-1000-AP - ZoneSafe Vehicle-to-Pedestrian Antenna**

**5882**

- 12-24Vdc
- Detection radius range: 0 - 10m (Configurable between 3 & 10m)
- Size (WxHxD)  
122 x 250 x 90mm
- IP67
- 2 Year Warranty

### Features

- Creates a detection zone around a vehicle
- Detects tags through walls and obstructions and around blind corners
- Detection zone radius programmable manually or via WIFI
- Connects to Control Unit on vehicle (antenna cable available separately)
- Daisy-chain wiring to connect multiple antennas to the same vehicle
- TX Frequency: 125kHz
- RX Frequency: 868.3MHz

### Power

- Current: 1 Amp

### Durability & Standards

- Operating temperature: -40 to +85C
- CE marked

**Note:** Antenna cable required for installation

## OPTIONAL EXTRA



**ZS-C130**

**Antenna Cable, 30m**

**5899**

**ZS-AP-MP**

**Mounting Plate for Pedestrian Antenna**

**5898**

**ZS-1000-BKT**

**Adjustable-Angle Mounting Bracket**

**6079**

## Zonesafe® RFID Tags

ZoneSafe RFID tags can be used to detect people, protect assets and to create exclusion zones. Each tag can be uniquely identified and linked to individual people. Driver tags have the same functionality as pedestrian tags and are also compatible with the control unit.

### • VibraTag Pedestrian Tag & VibraTag Driver Tag

Carried by personnel. VibraTags provide short bursts of vibration when detected. The robust tag is hermetically sealed and the high-capacity battery can be wirelessly charged within two hours and can last up to three months between charges.

### • AssetTag

AssetTags fit into safety cones to create exclusion zones. The robust tags are shockproof and weatherproof. The replaceable batteries last up to three years under normal use. AssetTags fit into safety cones with a 39 - 44mm diameter neck opening.

## Model

## Part No:

### NEW ZONESAFE® RFID TAG DETECTION SYSTEM



Pedestrian VibraTag



Driver VibraTag



Clip for Pedestrian VibraTag



ZS-1000-PVT - ZoneSafe® Pedestrian VibraTag, rechargeable	5889
ZS-1000-DVT - ZoneSafe® Driver VibraTag, rechargeable	5888
ZS-1000-TC - ZoneSafe® Clip for Pedestrian VibraTag (with fixings)	5892

- 12-24 Vdc
- Size (WxHxD)  
84 x 53 x 12mm
- IP67
- 1 Year Warranty

#### Features

- Carried by workers and machine operators
- Each tag can be uniquely identified and linked to individual people
- Driver tags have the same detection functionality as pedestrian tags and are also compatible with the control unit
- Driver tag is masked from detection when inserted into the control unit
- Tag Immediately vibrates upon entering a vehicle detection perimeter
- High-capacity rechargeable battery

- 2 hour inductive charging time using wireless charger (available separately)
- Hermetically sealed to provide best long term protection
- Can be worn on a lanyard, into pockets or armbands
- RX Frequency: 125kHz
- TX Frequency: 868.3MHz

#### Durability & Standards

- Operating temperature: -10 to +55C
- CE marked

### OPTIONAL EXTRA

ZS-1000-TWC ZoneSafe® Wireless VibraTag charger	5893
---	------

### NEW ZONESAFE® RFID TAG DETECTION SYSTEM



ZS-1000-AT - ZoneSafe® AssetTag	5894
---------------------------------	------

- Size (HxDia)  
63 x 48mm
- IP67
- 1 Year Warranty

#### Features

- High-capacity (non-rechargeable) replaceable power cell providing long operational life (included)
- Protects vehicle from collisions with property or hazards
- Immediately warns the driver when tag is detected within the vehicle's detection zone
- Robust and waterproof enclosure

- Can be attached onto assets or mounted on top of a safety cone with neck opening diameter of 39-44mm
- RX Frequency: 125kHz
- TX Frequency: 868.3MHz

#### Durability & Standards

- Operating temperature: -10 to +55C
- CE marked

### OPTIONAL EXTRA

ZS-BAT-AT - Replacement battery for Asset Tag	5896
---	------

# Zonesafe® RFID Detection

Model

Part No:

## NEW ZONESAFE® RFID TAG DETECTION SYSTEM



ZS-1000-TT - ZoneSafe® Tag Tester

5883

- 24 Vdc (external 24V DC supplied)
- Size (WxHxD) 110 x 90 x 55mm
- IP67
- 1 Year Warranty

### Features

- Checks pedestrian and driver tag battery status (green for good and red for low)
- Includes 2 relays which can be used to trigger alarms, locks or shutters
- Adjustable Tag detection range from 0.1 to 4m
- TX Frequency: 125kHz
- RX Frequency: 868.3MHz

### Power

- Current: 0.5 Amp

### Durability & Standards

- Operating temperature: -10 to +55C
- CE marked

## NEW ZONESAFE® RFID TAG DETECTION SYSTEM



ZS-1000-MZ - ZoneSafe® Masking Zone Antenna

5885

- 24 Vdc (external 24V DC supplied)
- Size (WxHxD) 250 x 122 x 90mm
- IP67
- 1 Year Warranty

### Features

- Fitted to walls or other permanent structures
- Makes all tags within the masked area undetectable
- Adjustable masking zone from 3 to 10m
- Tags will be detected as normal once outside the masked area
- TX Frequency: 125kHz

### Power

- Current: 1 Amp

### Durability & Standards

- Operating temperature: -40 to +85C
- CE marked

## OPTIONAL EXTRA



ZS-AP-MP Mounting Plate for Pedestrian Antenna

5898

ZS-1000-BKT Adjustable-Angle Mounting Bracket

6079

## NEW ZONESAFE® RFID TAG DETECTION SYSTEM



ZS-1000-SG - ZoneSafe® Smart Gateway

5886

- 24 Vdc (external 24V DC supplied)
- Size (WxHxD) 110 x 90x 55mm
- IP67
- 1 Year Warranty

### Features

- Fitted to walls or other permanent structures
- 2 x relays which can be used to trigger alarms or open shutters, barriers etc
- Detects approaching vehicles equipped with ZoneSafe systems
- Adjustable detection range from 3 to 9m
- RX Frequency: 125kHz
- TX Frequency: 868.3MHz

### Power

- Current: 0.5 Amp

### Durability & Standards

- Operating temperature: -10 to +55C
- CE marked

## NEW ZONESAFE® RFID TAG DETECTION SYSTEM



ZS-1000-DR - ZoneSafe® Desktop Reader

5887

- Size (HxDia) 160 x80 x 45mm
- 5V USB connection
- 1 Year Warranty

### Features

- Checks VibraTag battery status (green for good and red for low)
- Can be powered from any computer via USB
- TX Frequency: 125kHz
- RX Frequency: 868.3MHz

### Durability & Standards

- Operating temperature: -10 to +55C

# Warranties

LIFETIME

## Lifetime New-For-Old Warranty (covers product for the life of vehicle)

bbs-tek® White sound® reversing alarms  
Self-adjusting backalarms

5  
YEARS

## 5 Year New-For-Old Warranty

Backeye®360 camera system  
ELITE range camera monitor systems

3  
YEARS

## 3 Year New-For-Old Warranty

SELECT range camera monitor systems  
MDR mobile digital recorders, IP cameras and accessories  
Ultrasonic object detection systems  
Backsense® radar object detection systems  
Digital wireless camera monitor connection

2  
YEARS

## 2 Year New-For-Old Warranty

Camera monitor system ancillaries  
Ultrasonic object detection on-screen display  
Ultrasonic object detection ancillaries and extras  
Alarm ancillaries  
Backchat® Speaking alarms  
Vehicle intercom  
QVS Quiet vehicle sounder

1  
YEAR

## 1 Year New-For-Old Warranty\*

ESSENTIAL camera monitor systems  
ZoneSafe® RFID systems  
All products aside those specifically listed

## Warranty Terms and Conditions

Brigade warrants all goods to be free from defect in material and workmanship in normal use provided that they have been installed and operated in accordance with the instructions supplied. Normal wear-and-tear excluded. The commencement date of all warranties is the date of delivery to the purchaser unless otherwise agreed in writing by Brigade. The period during which the warranty applies is stated above. Brigade make no other warranty, express or implied, with respect to the goods, their marketability, quality or fitness for any particular use or purpose. In particular, but without prejudice to the general provisions of the conditions of sale, no responsibility is assumed for incidental or consequential loss by reason of any warranty express or implied. Full details of Brigade's Terms and Conditions can be found at [brigade-electronics.com](http://brigade-electronics.com).

# Index by Model Number

Model	Part	Page	Model	Part	Page	Model	Part	Page
AC-006	1983	42	BE-801C(40)	2085	21	BS-09DCX	4551	65
AC-007	1984	42	BE-801C(78)	2084	21	BS-25DCSX	4975	65
AC-007	1984	66	BE-810C	1242	20	BS-4000W	3744	57
AC-014	2094	42	BE-820C	1927	21	BS-7030	4527	65
AC-014(5M)	5049	42	BE-821C	2002	21	BS-7045	4528	65
AC-016	2150	43	BE-822C	2151	21	BS-7060	4529	65
AC-019	2589	43	BE-823C	5100	21	BS-8000	4530	64
AC-020	2590	42	BE-850C	4924	21	BS-9000	5266	67
AC-020	2590	66	BE-856G-000	4012	24	BS-9000-WD	5713	64
AC-021	2704	43	BE-856GM	3756	19	BS-9001-OSD	5658	66
AC-024	3183	43	BE-870FM	2146	19	BS-9001-USB	5656	66
AC-028	3335	43	BE-870L-000	3231	24	BS-WD-USB	5637	64
AC-035	3702	42	BE-870L-100	4032	24	CS-020	1571	44
AC-041	4245	43	BE-870LM	2705	19	CS-3100	5261	60
AC-042	4246	43	BE-890C	2871	21	CT-470	1346	64
AC-044	4279	43	BE-891C	5426	21	DMC-1021	5715	34
AC-045	4280	43	BE-900C	5277	20	DMC-1025	5717	34
AC-055(5M)	4267	42	BE-901C	5278	20	DMC-1031	5719	27
AC-056	4401	42	BE-970WFM	3560	18	DMC-1035	5721	27
AC-062	4691	42	BE-970WM	3351	18	DW-1000-RX	4044	44
AC-063	4925	42	BE-990C	5279	20	DW-1000-TX	4043	44
AC-064	4948	43	BE-991C	5280	20	EDM-50	2152	45
AC-066	5027	42	BE-L1003	2797	22	FS-4000W	3747	60
AC-067	5028	42	BE-L101	5042	22	IP-1000C	5935	52
AC-068	5234	43	BE-L105	0804	22	IP-1100C	5936	53
AC-069	5318	43	BE-L108	3007	22	IP-1200C	5937	52
AC-24-12(002)	4266	43	BE-L110	0803	22	IP-1XXX-PC	5985	53
AC-24-12(004)	4281	43	BE-L112	3008	22	IP-EC-1	5865	53
AC-24-12(006)	4719	43	BE-L115	0802	22	IP-EC-5	5866	53
AC-24-12(007)	4762	43	BE-L120	0801	22	IP-EM-PC	5864	53
AC-24-12(008)	4763	43	BE-L130	0800	22	IP-EM4	5860	53
AC-24-12(009)	4926	42	BE-X003	0805	22	IP-EM8	5861	53
AC-305	4903	13	BE-X005	2099	22	IP-L601	5867	53
AC-305	4903	42	BE-X010	2100	22	IP-L603	5902	53
AC-305	4903	51	BE-X015	2101	22	IP-L605	5903	53
AC-306	4904	42	BE-X020	1143	22	IP-L610	5982	53
AC-306	4904	51	BE-X025	1907	22	IP-L615	5904	53
AC-307	4905	42	BE360-CD	4701	12	IP-L620	5983	53
AC-307	4905	51	BKT-017	4676	65	IP-L630	5984	53
AC-308	4949	42	BKT-018	4758	65	IP-L630	5984	53
BBS-102	0898	70	BMM-019-ARM	3348	31	LS-60-A	4851	44
BBS-107	0899	70	BN-360-100C-BKT01	4649	12	LS-60-A	4851	59
BBS-82	0896	71	BN360-100C-BKT02	4714	12	MD-50	5735	34
BBS-82HV	1322	70	BN360-100C-BKT03	4743	12	MD-50(SW)	5683	34
BBS-87	0897	71	BN360-300	5800	12	MD-50(W)	5692	34
BBS-92	0934	71	BN360-Enclosure	4723	13	MD-50AM-15	5004	28
BBS-92ADR	2165	70	BN360-H3025	5813	12	MD-50AM-15	5004	34
BBS-97	0935	71	BN360-H305	5812	12	MD-50AM-25	5005	28
BC-01	0077	72	BN360-H310	5811	12	MD-50AM-25	5005	34
BC-01(4W)(H/BRAKE)	1715	72	BN360-H315	5810	12	MD-50SM-30	5003	28
BC-01(B)	0079	72	BN360-H320	5809	12	MD-50SM-30	5003	34
BC-01(H/BRAKE)	0849	72	BN360-L1025	4499	13	MD-51	5736	34
BC-01(NS-B)	1198	72	BN360-L105	4498	13	MD-51(SW)	5686	34
BC-01(NS)	0378	72	BN360-L110	4496	13	MD-51(W)	5694	34
BC-02(B)	0083	72	BN360-L115	4495	13	MD-60	5737	28
BC-VI	0815	73	BN360-L120	4493	13	MD-60(SW)	5688	28
BC-VI-2	0875	73	BNC-360-200	5200	13	MD-60(W)	5696	28
BE-800C	1623	21	BS-00NT	5291	65	MD-61	5738	28
BE-800C-NIR	4247	21	BS-00NYC	5270	65	MD-61(SW)	5690	28
BE-800C(40)	1559	21	BS-02DCX	5272	65	MD-61(W)	5698	28
BE-800C(78)	1426	21	BS-02PIC	5271	65	MDR-03GSC	4874	51
BE-801C	1905	21	BS-05DCX	4550	65	MDR-06RPC	4873	51



Model	Part	Page	Model	Part	Page	Model	Part	Page
MDR-500-1000-MCU	5157	51	SP-15B-01	3422	23	VBV-770-001DW	4767	38
MDR-500-2000-MCU	5330	51	SP-15B-04	3956	23	VBV-770-100	4695	39
MDR-500-500-MCU	5132	51	SP-15B-05	5065	36	VBV-770-101	4772	38
MDR-504-1000	5561	50	SP-7A	1827	22	VBV-770-300	4777	39
MDR-504-2000	5563	50	SP-7B	1828	22	VBV-770-310	4781	40
MDR-504G-1000	5569	50	SS-002	3044	45	VBV-770FM	4982	31
MDR-504G-2000	5571	50	SS-4100W	5257	59	VBV-770H-3000	6112	29
MDR-504GW-1000	5573	50	SS-4100W-000	5344	59	VBV-770H-3100	6113	29
MDR-504GW-2000	5575	50	SS-4200W	5916	58	VBV-770H-7000	6111	29
MDR-504W-1000	5565	50	SS-4200W-000	6075	58	VBV-770HM	5611	25
MDR-504W-2000	5567	50	SS-BC-08	1334	59	VBV-770M	4288	30
MDR-508-1000	5126	49	SS-BC-08	1334	72	VBV-770M-S	4697	30
MDR-508-2000	5577	49	ST-2100	5262	61	VBV-790C	2724	32
MDR-508G-1000	5128	49	ST-2100-60-A	5345	61	VBV-791C	2842	32
MDR-508G-2000	5583	49	TCO-41-01	4752	73	VBV-H4025	5522	28
MDR-508G-EXP-0	5310	51	TCO-47	0663	73	VBV-H405	5519	28
MDR-508GW-1000	5127	49	TCO-47-01	4752	59	VBV-H410	5516	28
MDR-508GW-2000	5585	49	TS-001ECU	1362	59	VBV-H415	5514	28
MDR-508GW-EXP-0	5309	51	UDS-10BC	3716	57	VBV-H420	5513	28
MDR-508W-1000	5129	49	UDS-10BC	3716	61	VBV-L4020	5773	41
MDR-508W-2000	5579	49	UDS-15BC	3746	61	VBV-L4025	1554	35
MDR-508W-EXP-0	5311	51	UDS-2.5BC	3717	61	VBV-L403	4977	35
MDR-FPB32-01	4896	51	UDS-2.5SC	3719	61	VBV-L405	1499	35
MDR-GS-02	4988	51	UDS-4.5SC	3720	61	VBV-L406	3152	35
MDR-RP01	4872	51	UDS-7.0SC	5623	61	VBV-L407	3151	35
NS-2	0334	73	UDS-OSD20-ECU	5099	56	VBV-L410	1386	35
NS-3	0974	73	UDS-OSD21-ECU	5347	56	VBV-L412	3106	35
QVS-001-75	5387	71	UDS-RELAY-12	4216	57	VBV-L415	3150	35
SA-BBS-107	1400	70	UDS-RELAY-24	4215	57	VBV-L420	1380	35
SA-BBS-97	1399	70	VBV-3000C	5454	27	VBV-L430	2108	35
SA-BBS-97HV	1398	70	VBV-3001C	5455	27	VBV-L505	4001	35
SC-07	1046	22	VBV-300C	5211	33	VBV-L510	3663	35
SC-07-24S	1227	36	VBV-301C	5213	33	VBV-L520	3664	35
SC-1000-ECU	3666	45	VBV-3020C	5456	27	VCS-020	1844	44
SC-15-01	3268	23	VBV-3021C	5457	27	VSK-305E	3871	37
SC-15-01	3268	36	VBV-320C	5215	33	VSK-30E	2538	37
SC-7	1829	22	VBV-321C	5217	33	VSK-30E-T	2542	37
SD-32GB-IND	4875	51	VBV-481C	2843	33	VSK-31E	2539	37
SD-64GB-IND	4876	51	VBV-485C	2199	33	VSK-31E-T	2543	37
SE-7104F-100	5378	13	VBV-630C	5772	41	VSK-505E	4005	36
SE-770-100	5379	13	VBV-631C	5817	41	VSK-50E	2540	36
SE-770H-300	6144	12	VBV-650-000	4765	41	VSK-50E-A	2540	36
SK-15-01	3427	23	VBV-650-000N	4766	41	VSK-50E-T	2542	36
SK-15-04	3997	23	VBV-670-000	5774	41	VSP-47A	1847	36
SK-15-04	3997	57	VBV-671-000	5816	41	VSP-47B	1846	36
SK-15-05	5066	13	VBV-7000C	5464	26	VSP-57A	3869	36
SK-15-05	5066	36	VBV-7001C	5465	26	VSP-57B	3870	36
SK-30E	1144	22	VBV-700C	1379	32	ZS-1000-AP	5882	76
SK-30E-T	1885	22	VBV-701C	2575	32	ZS-1000-AT	5894	77
SK-31E	1830	22	VBV-7090C	5468	26	ZS-1000-BKT	6079	76
SK-31E-T	1886	22	VBV-7091C	5469	26	ZS-1000-DR	5887	78
SK-31E-T	1886	23	VBV-7100C	5466	26	ZS-1000-DVT	5888	77
SK-50E	1570	23	VBV-7101C	5467	26	ZS-1000-ECU	5881	76
SK-50E-A	1879	23	VBV-7104FM	4474	30	ZS-1000-MZ	5885	78
SK-UDS-05	4219	57	VBV-710C	2808	32	ZS-1000-PVT	5889	77
SM-3XX-25	4596	27	VBV-7190C	5470	26	ZS-1000-SG	5886	78
SM-3XX-25	4596	33	VBV-750-000	4705	39	ZS-1000-TC	5892	77
SP-07C	1140	22	VBV-750-310	4780	40	ZS-1000-TT	5883	78
SP-07T	1142	22	VBV-750M	4287	31	ZS-1000-TWC	5893	77
SP-15A-01	3423	23	VBV-750M-S	4710	31	ZS-AP-MP	5898	76
SP-15A-04	3955	23	VBV-770-000	4692	39	ZS-C130	5899	76
SP-15A-05	5064	36	VBV-770-001DW	4843	38	ZS-ECU-MP	5900	76

# Index by Part Number

Part	Model	Page	Part	Model	Page	Part	Model	Page
0077	BC-01	72	1927	BE-820C	21	3719	UDS-2.5SC	61
0079	BC-01(B)	72	1983	AC-006	42	3720	UDS-4.5SC	61
0083	BC-02(B)	72	1984	AC-007	42	3744	BS-4000W	57
0334	NS-2	73	1984	AC-007	66	3746	UDS-15BC	61
0378	BC-01(NS)	72	2002	BE-821C	21	3747	FS-4000W	60
0663	TCO-47	73	2084	BE-801C(78)	21	3756	BE-856GM	19
0800	BE-L130	22	2085	BE-801C(40)	21	3869	VSP-57A	36
0801	BE-L120	22	2094	AC-014	42	3870	VSP-57B	36
0802	BE-L115	22	2099	BE-X005	22	3871	VSK-305E	37
0803	BE-L110	22	2100	BE-X010	22	3955	SP-15A-04	23
0804	BE-L105	22	2101	BE-X015	22	3956	SP-15B-04	23
0805	BE-X003	22	2108	VBV-L430	35	3997	SK-15-04	23
0815	BC-VI	73	2146	BE-870FM	19	3997	SK-15-04	57
0849	BC-01(H/BRAKE)	72	2150	AC-016	43	4001	VBV-L505	35
0875	BC-VI-2	73	2151	BE-822C	21	4005	VSK-505E	36
0896	BBS-82	71	2152	EDM-50	45	4012	BE-856G-000	24
0897	BBS-87	71	2165	BBS-92ADR	70	4032	BE-870L-100	24
0898	BBS-102	70	2199	VBV-485C	33	4043	DW-1000-TX	44
0899	BBS-107	70	2538	VSK-30E	37	4044	DW-1000-RX	44
0934	BBS-92	71	2539	VSK-31E	37	4215	UDS-RELAY-24	57
0935	BBS-97	71	2540	VSK-50E	36	4216	UDS-RELAY-12	57
0974	NS-3	73	2540	VSK-50E-A	36	4219	SK-UDS-05	57
1046	SC-07	22	2542	VSK-30E-T	37	4245	AC-041	43
1140	SP-07C	22	2542	VSK-50E-T	36	4246	AC-042	43
1142	SP-07T	22	2543	VSK-31E-T	37	4247	BE-800C-NIR	21
1143	BE-X020	22	2575	VBV-701C	32	4266	AC-24-12(002)	43
1144	SK-30E	22	2589	AC-019	43	4267	AC-055(5M)	42
1198	BC-01(NS-B)	72	2590	AC-020	42	4279	AC-044	43
1227	SC-07-24S	36	2590	AC-020	66	4280	AC-045	43
1242	BE-810C	20	2704	AC-021	43	4281	AC-24-12(004)	43
1322	BBS-82HV	70	2705	BE-870LM	19	4287	VBV-750M	31
1334	SS-BC-08	59	2724	VBV-790C	32	4288	VBV-770M	30
1334	SS-BC-08	72	2797	BE-L1003	22	4401	AC-056	42
1346	CT-470	64	2808	VBV-710C	32	4474	VBV-7104FM	30
1362	TS-001ECU	59	2842	VBV-791C	32	4493	BN360-L120	13
1379	VBV-700C	32	2843	VBV-481C	33	4495	BN360-L115	13
1380	VBV-L420	35	2871	BE-890C	21	4496	BN360-L110	13
1386	VBV-L410	35	3007	BE-L108	22	4498	BN360-L105	13
1398	SA-BBS-97HV	70	3008	BE-L112	22	4499	BN360-L1025	13
1399	SA-BBS-97	70	3044	SS-002	45	4527	BS-7030	65
1400	SA-BBS-107	70	3106	VBV-L412	35	4528	BS-7045	65
1426	BE-800C(78)	21	3150	VBV-L415	35	4529	BS-7060	65
1499	VBV-L405	35	3151	VBV-L407	35	4530	BS-8000	64
1554	VBV-L4025	35	3152	VBV-L406	35	4550	BS-05DCX	65
1559	BE-800C(40)	21	3183	AC-024	43	4551	BS-09DCX	65
1570	SK-50E	23	3231	BE-870L-000	24	4596	SM-3XX-25	27
1571	CS-020	44	3268	SC-15-01	23	4596	SM-3XX-25	33
1623	BE-800C	21	3268	SC-15-01	36	4649	BN-360-100C-BKT01	12
1715	BC-01(4W)(H/BRAKE)	72	3335	AC-028	43	4676	BKT-017	65
1827	SP-7A	22	3348	BMM-019-ARM	31	4691	AC-062	42
1828	SP-7B	22	3351	BE-970WM	18	4692	VBV-770-000	39
1829	SC-7	22	3422	SP-15B-01	23	4695	VBV-770-100	39
1830	SK-31E	22	3423	SP-15A-01	23	4697	VBV-770M-S	30
1844	VCS-020	44	3427	SK-15-01	23	4701	BE360-CD	12
1846	VSP-47B	36	3560	BE-970WFM	18	4705	VBV-750-000	39
1847	VSP-47A	36	3663	VBV-L510	35	4710	VBV-750M-S	31
1879	SK-50E-A	23	3664	VBV-L520	35	4714	BN360-100C-BKT02	12
1885	SK-30E-T	22	3666	SC-1000-ECU	45	4719	AC-24-12(006)	43
1886	SK-31E-T	22	3702	AC-035	42	4723	BN360-Enclosure	13
1886	SK-31E-T	23	3716	UDS-10BC	57	4743	BN360-100C-BKT03	12
1905	BE-801C	21	3716	UDS-10BC	61	4752	TCO-41-01	73
1907	BE-X025	22	3717	UDS-2.5BC	61	4752	TCO-47-01	59

Part	Model	Page	Part	Model	Page	Part	Model	Page
4758	BKT-018	65	5234	AC-068	43	5692	MD-50(W)	34
4762	AC-24-12(007)	43	5257	SS-4100W	59	5694	MD-51(W)	34
4763	AC-24-12(008)	43	5261	CS-3100	60	5696	MD-60(W)	28
4765	VBV-650-000	41	5262	ST-2100	61	5698	MD-61(W)	28
4766	VBV-650-000N	41	5266	BS-9000	67	5713	BS-9000-WD	64
4767	VBV-770-001DW	38	5270	BS-00NYC	65	5715	DMC-1021	34
4772	VBV-770-101	38	5271	BS-02PIC	65	5717	DMC-1025	34
4777	VBV-770-300	39	5272	BS-02DCX	65	5719	DMC-1031	27
4780	VBV-750-310	40	5277	BE-900C	20	5721	DMC-1035	27
4781	VBV-770-310	40	5278	BE-901C	20	5735	MD-50	34
4843	VBV-770-001DW	38	5279	BE-990C	20	5736	MD-51	34
4851	LS-60-A	44	5280	BE-991C	20	5737	MD-60	28
4851	LS-60-A	59	5291	BS-00NT	65	5738	MD-61	28
4872	MDR-RP01	51	5309	MDR-508GW-EXP-0	51	5772	VBV-630C	41
4873	MDR-06RPC	51	5310	MDR-508G-EXP-0	51	5773	VBV-L4020	41
4874	MDR-03GSC	51	5311	MDR-508W-EXP-0	51	5774	VBV-670-000	41
4875	SD-32GB-IND	51	5318	AC-069	43	5800	BN360-300	12
4876	SD-64GB-IND	51	5330	MDR-500-2000-MCU	51	5809	BN360-H320	12
4896	MDR-FPB32-01	51	5344	SS-4100W-000	59	5810	BN360-H315	12
4903	AC-305	13	5345	ST-2100-60-A	61	5811	BN360-H310	12
4903	AC-305	42	5347	UDS-OSD21-ECU	56	5812	BN360-H305	12
4903	AC-305	51	5378	SE-7104F-100	13	5813	BN360-H3025	12
4904	AC-306	42	5379	SE-770-100	13	5816	VBV-671-000	41
4904	AC-306	51	5387	QVS-001-75	71	5817	VBV-631C	41
4905	AC-307	42	5426	BE-891C	21	5860	IP-EM4	53
4905	AC-307	51	5454	VBV-3000C	27	5861	IP-EM8	53
4924	BE-850C	21	5455	VBV-3001C	27	5864	IP-EM-PC	53
4925	AC-063	42	5456	VBV-3020C	27	5865	IP-EC-1	53
4926	AC-24-12(009)	42	5457	VBV-3021C	27	5866	IP-EC-5	53
4948	AC-064	43	5464	VBV-7000C	26	5867	IP-L601	53
4949	AC-308	42	5465	VBV-7001C	26	5881	ZS-1000-ECU	76
4975	BS-25DCSX	65	5466	VBV-7100C	26	5882	ZS-1000-AP	76
4977	VBV-L403	35	5467	VBV-7101C	26	5883	ZS-1000-TT	78
4982	VBV-770FM	31	5468	VBV-7090C	26	5885	ZS-1000-MZ	78
4988	MDR-GS-02	51	5469	VBV-7091C	26	5886	ZS-1000-SG	78
5003	MD-50SM-30	28	5470	VBV-7190C	26	5887	ZS-1000-DR	78
5003	MD-50SM-30	34	5513	VBV-H420	28	5888	ZS-1000-DVT	77
5004	MD-50AM-15	28	5514	VBV-H415	28	5889	ZS-1000-PVT	77
5004	MD-50AM-15	34	5516	VBV-H410	28	5892	ZS-1000-TC	77
5005	MD-50AM-25	28	5519	VBV-H405	28	5893	ZS-1000-TWC	77
5005	MD-50AM-25	34	5522	VBV-H4025	28	5894	ZS-1000-AT	77
5027	AC-066	42	5561	MDR-504-1000	50	5898	ZS-AP-MP	76
5028	AC-067	42	5563	MDR-504-2000	50	5899	ZS-C130	76
5042	BE-L101	22	5565	MDR-504W-1000	50	5900	ZS-ECU-MP	76
5049	AC-014(5M)	42	5567	MDR-504W-2000	50	5902	IP-L603	53
5064	SP-15A-05	36	5569	MDR-504G-1000	50	5903	IP-L605	53
5065	SP-15B-05	36	5571	MDR-504G-2000	50	5904	IP-L615	53
5066	SK-15-05	13	5573	MDR-504GW-1000	50	5916	SS-4200W	58
5066	SK-15-05	36	5575	MDR-504GW-2000	50	5935	IP-1000C	52
5099	UDS-OSD20-ECU	56	5577	MDR-508-2000	49	5936	IP-1100C	53
5100	BE-823C	21	5579	MDR-508W-2000	49	5937	IP-1200C	52
5126	MDR-508-1000	49	5583	MDR-508G-2000	49	5982	IP-L610	53
5127	MDR-508GW-1000	49	5585	MDR-508GW-2000	49	5983	IP-L620	53
5128	MDR-508G-1000	49	5611	VBV-770HM	25	5984	IP-L630	53
5129	MDR-508W-1000	49	5623	UDS-7.0SC	61	5984	IP-L630	53
5132	MDR-500-500-MCU	51	5637	BS-WD-USB	64	5985	IP-1XXX-PC	53
5157	MDR-500-1000-MCU	51	5656	BS-9001-USB	66	6075	SS-4200W-000	58
5200	BNC-360-200	13	5658	BS-9001-OSD	66	6079	ZS-1000-BKT	76
5211	VBV-300C	33	5683	MD-50(SW)	34	6111	VBV-770H-7000	29
5213	VBV-301C	33	5686	MD-51(SW)	34	6112	VBV-770H-3000	29
5215	VBV-320C	33	5688	MD-60(SW)	28	6113	VBV-770H-3100	29
5217	VBV-321C	33	5690	MD-61(SW)	28	6144	SE-770H-300	12

# Glossary

## **ADPCM**

An audio file format, optimized for storing digitised data at a low sampling rate.

## **AHD**

Analogue high definition video standard that uses standard cable to transmit HD video from cameras to Monitor/DVR

## **Amp**

Unit of electric current.

## **Auto-trigger**

Enables automatic triggering of an action e.g. display of rear camera view when reverse gear engaged.

## **AVAS**

Acoustic Vehicle Alert System (AVAS) automatically emits an external synthesized sound to enable pedestrians to be audibly aware of the vehicle's presence.

## **A/V input/output**

Communication connection between electronic devices.

### **- Input**

Receives audio/visual signals such as from DVD or satellite navigation

### **- Output**

Sends audio/visual signals to other devices such as to mobile digital recorder.

## **Brightness**

Brightness of the picture displayed on a monitor, measured in candelas per square metre (cd/m<sup>2</sup>). Higher the measure the brighter the picture.

## **CAN bus**

Controller Area Network is a robust vehicle standard designed to allow microcontrollers and devices to communicate with each other without a host computer.

A Controller Area Network (CAN bus) is a robust vehicle bus standard designed to allow microcontrollers and devices to communicate with each others' applications without a host computer.

## **CCD (Charged-Coupled Device)**

A tiny photocell used in cameras to convert light into a digital signal.

## **Contrast**

Light intensity ratio of a display device between darkest and lightest colour produced.

## **CE mark**

Confirmation that a product is in conformity with the essential requirements of any applicable directives e.g. 2004/108/EC (relating to Electromagnetic Compatibility).

## **CVBS**

Composite Video Blanking and Sync. An analogue video signal format that carries standard-definition video as a single channel.

## **Decibel (dB)**

Unit of measure of the pressure (intensity) of sound. The higher the rating the more intense the sound.

## **DWDR (Digital Wide Dynamic Range)**

Digitally Produces a greater dynamic range of luminosity for improved detail in highlights and shadows.

## **EMC (Electro-magnetic compatibility)**

Regulation concerning the type-approval tests for European automotive electronics.

### **- E**

United Nations mark for approved vehicle components sold into the EU. And in some other countries under UN-ECE Regulation 10

## **EN 13309:2010**

Construction machinery. Electromagnetic compatibility of machines with internal power supply

## **FCC mark**

Certification for electromagnetic interference on products manufactured or sold in the United States which comply with the Federal Communications Commission.

## **FMCW**

Frequency-Modulated Continuous Wave radar. A known stable frequency continuous wave is transmitted and then received from any reflecting objects.

## **Frequency**

Number of times a sound source vibrates per unit of time, measured in hertz (Hz). The higher the rating the higher the pitch.

## **GPS (Global Positioning System)**

Global satellite system providing positioning and timing services to worldwide users on a continuous basis.

## **HALT (Highly Accelerated Life Test)**

A comprehensive stress test applied to electronic equipment to identify design weakness.

## **IC (Industry Canada)**

Certification for electromagnetic interference on products manufactured or sold in Canada which comply with the Bureau of Innovation, Science & Economic Development

## **Illumination distance (camera)**

Distance a camera with infrared LEDs can see in ultra-low light conditions, measured in metres.

### **IP## (Ingress Protection)**

An international classification for the sealing of electrical equipment against the intrusion of solid objects (digit 1) and liquids (digit 2). Higher the rating the better protection in each case.

### **ISO 13766**

Specific standard for earthmoving equipment, includes requirements for some additional tests that are not covered in the tests for 'E' or 'e' under EMC.

### **ISO 16750**

Standard providing guidance regarding environmental conditions commonly encountered by electrical and electronic systems installed in vehicles.

### **ISO 20653: 2006**

Road vehicles — Degrees of protection (IP-Code) of electrical equipment against foreign objects, water and access

### **LCD (Liquid Crystal Display)**

Thin, flat display device made up of any number of colour or monochrome pixels i.e. monitor screen.

### **LED (Light Emitting Diode (camera))**

Emits infrared light for high efficiency and performance in ultra-low light.

### **LED (Light Emitting Diode (monitor))**

Used to back light the monitor display for crisp images and superior image quality.

### **Mechanical shock**

Level of sudden acceleration or deceleration, such as impact or being dropped, to which product will still perform. Measured in gravitational force (G).

### **Mechanical vibration**

Level of continuous or repetitive

motion, such as engine vibration, to which product will still perform. Measured in gravitational force (G).

### **NAS-PIEK**

The standard for quiet delivery vehicles in the UK, certified by the Noise Abatement Society.

### **NTSC (National Television Systems Committee)**

TV colour encoding standard.

### **PAL (Phase Alternating Line)**

TV colour encoding standard.

### **Quiet Mark**

An international approval associated with the UK Noise Abatement Society. It encourages companies worldwide to prioritise noise reduction.

### **R46**

UN ECE Regulation No 46 covers devices for indirect vision and their installation.

### **R118**

UN ECE Regulation No 118 determines the burning behaviour (ignitibility, burning rate and melting behaviour) of materials.

### **R138**

UN ECE Regulation concerning the approval of Quiet Road Transport Vehicles with regard to their reduced audibility.

### **Resolution (RGB)**

Number of pixels used to display an image. Measured in Width x 3 channels (Red, Green, Blue) x Height.

### **RoHS 2**

The restriction of the use of certain hazardous substances in electrical and electronic equipment

### **SAE J994**

Performance testing for electrically operated reversing alarms primarily intended for use on off-road, self-propelled construction and industrial machines.

### **Sounder unit**

Unit which produces the sound of an alarm.

### **TV Lines**

Number of horizontal lines used to create an image.

### **Viewing angles (camera)**

The maximum angle of vision.

### **Viewing angles (monitor)**

The maximum angle at which an image can be successfully viewed. Measured from the centre point on the monitor.

### **Vulnerable road user**

Road users most at risk in traffic – such as pedestrians, cyclists and public transport passengers. Children, older people and disabled people may also be included in this category.

### **Watt**

A measure of the electrical power needed to drive a product.

### **WDR (Wide Dynamic Range)**

Produces a greater dynamic range of luminosity for improved detail in highlights and shadows.

### **WiFi**

A facility allowing devices to communicate wirelessly. A wireless network creates a small, localised area within which your devices can receive signal.

### **4G**

A cellular data service available from mobile network providers.

# You're safer with us

Brigade is committed to making roads and worksites safer for all. From our humble beginnings in the UK, we now have a network of overseas subsidiaries and partnerships with international distributors, all chosen for their high level of service and expertise in vehicle safety.

Whether you operate an international, multi-vehicle fleet or a small business in a remote corner of the globe, We have a local specialist to help with your safety requirements. We can provide a solution for a specific problem or offer friendly advice and support if you are new to vehicle safety systems.

Wherever you are in the world, large road-going vehicles and mobile plant continue to be a danger. Thankfully, Health & Safety culture is gradually improving to help combat these dangers, but whatever the local obligation, there is no excuse for compromising on safety.

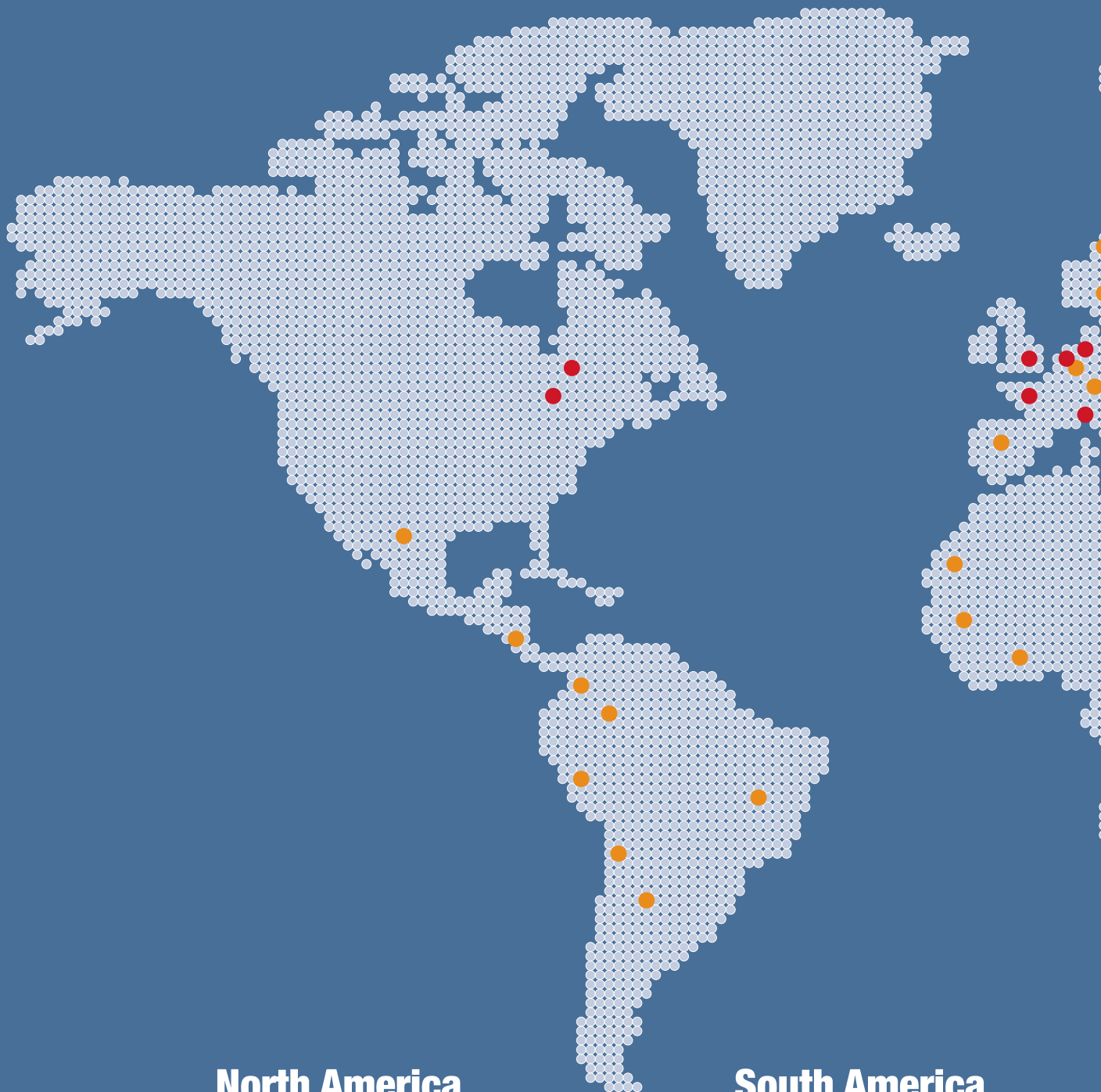

## North America

- Brigade Electronics Inc
- Brigade Electronics (Canada) Limited
- National Distributor in Mexico

## South America

- National Distributors in Brazil, Chile, Argentina, Peru, Bolivia, Colombia

## United Kingdom

- Brigade Electronics Group Plc
- Brigade Electronics (UK) Ltd
- Brigade Service Partners:  
Experienced, accredited technicians who provide service and support for anyone who has purchased our products. Operating from over 20 regional sites nationwide, each with fully equipped workshops and a team of engineers providing extensive parts availability, support and advice
- Nationwide network of approved fitters, mobile engineers and over 150 distributors

## Europe

- Brigade Elektronik GmbH
- Brigade Elettronica srl
- Brigade Electronics BV
- Brigade Electronics FRANCE SAS
- Brigade Electronics (Polska) sp. z o.o.
- National Distributors in Austria, Denmark, Finland, Norway, Spain, Sweden, Bulgaria, Czech Republic, Greece, Hungary, Baltic States, Romania, Russia, Serbia, Slovenia, Turkey, Kazakhstan

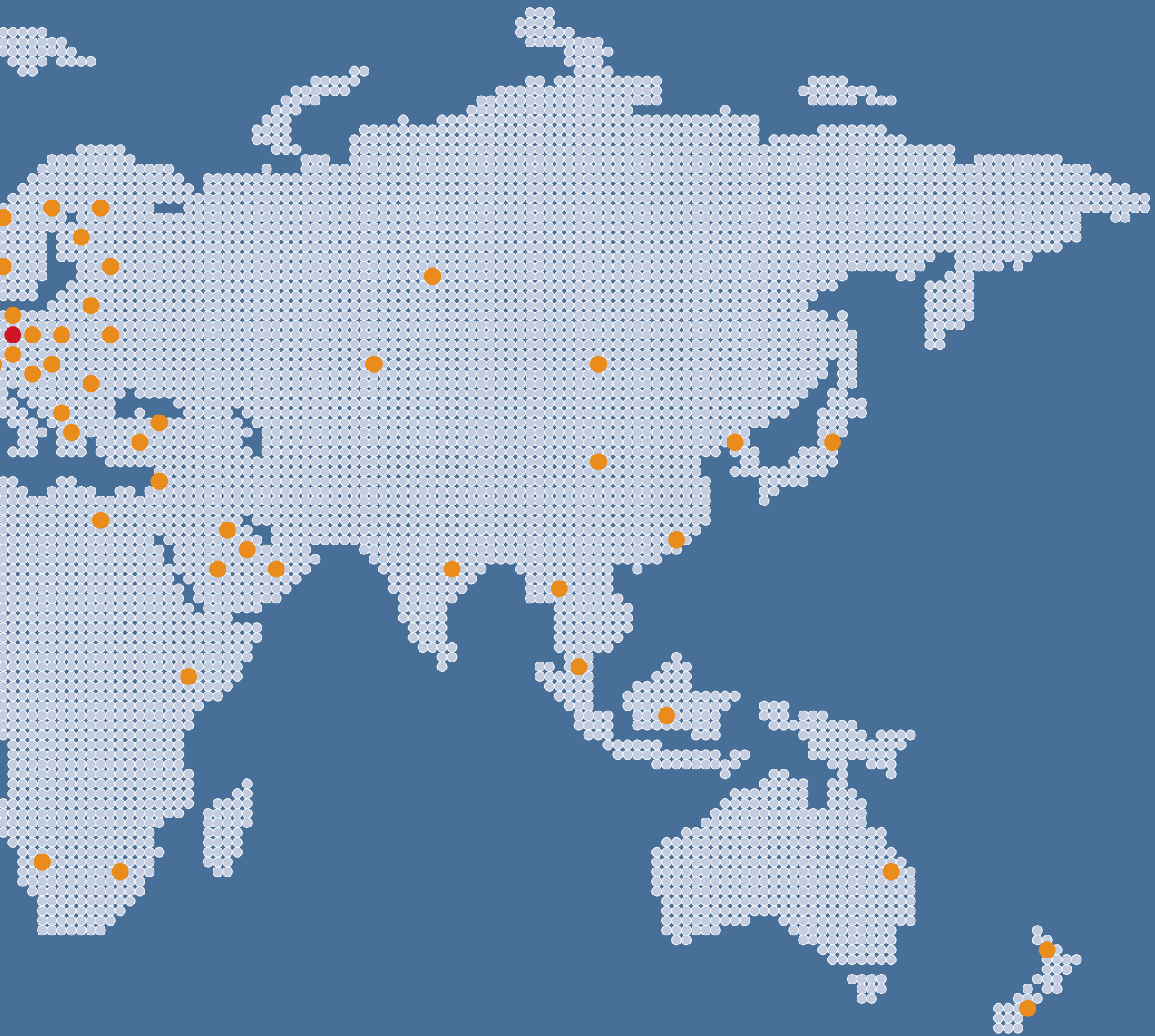

## Africa

- National Distributors in South Africa, Egypt, UAE, Oman, Israel

## Asia

- National Distributors in India, Pakistan, Mongolia, Hong Kong/China, Indonesia

## Australasia

- National Distributors in Australia, New Zealand

# Brigade Group

## **Brigade Electronics Group Plc**

Brigade House, The Mills  
Station Road, South Darenth  
DA4 9BD. United Kingdom  
Tel: +44 (0)1322 420300  
Email: [exportsales@brigade-electronics.com](mailto:exportsales@brigade-electronics.com)  
[www.brigade-electronics.com](http://www.brigade-electronics.com)

## **Brigade Electronics (UK) Ltd**

Brigade House, The Mills  
Station Road, South Darenth  
DA4 9BD. United Kingdom  
Tel: +44 (0)1322 420300  
Email: [sales@brigade-electronics.com](mailto:sales@brigade-electronics.com)  
[www.brigade-electronics.com](http://www.brigade-electronics.com)

## **Brigade Elektronik GmbH**

Havelstraße 21  
24539 Neumünster. Germany  
Tel: +49 (0) 4321 555 360  
Email: [info@brigadegmbh.de](mailto:info@brigadegmbh.de)  
[www.brigade-elektronik.de](http://www.brigade-elektronik.de)

## **Brigade Elettronica srl**

Corso Trapani, 16  
10139 Torino. Italy  
Tel: +39 011-0142105  
Email: [info-italia@brigade-electronics.com](mailto:info-italia@brigade-electronics.com)  
[www.brigade-elettronica.it](http://www.brigade-elettronica.it)

## **Brigade Electronics BV**

Ambachtstraat 8  
7587 BW de Lutte  
The Netherlands  
Tel: +31 541 53 18 01  
Email: [info@brigade-electronics.nl](mailto:info@brigade-electronics.nl)  
[www.brigade-electronics.nl](http://www.brigade-electronics.nl)

## **Brigade Electronics FRANCE SAS**

Siège social 92 avenue Robert Buron  
53000 Laval. France  
Tel : 02 99 03 60 34  
Email: [info@brigade-electronics.fr](mailto:info@brigade-electronics.fr)  
[www.brigade-electronics.fr](http://www.brigade-electronics.fr)

## **Brigade Electronics Inc**

215 E Pearl St.  
Portland, IN 47371. USA  
Tel: +1 (260) 766-4343  
Email: [sales@brigade-inc.com](mailto:sales@brigade-inc.com)  
[www.brigade-inc.com](http://www.brigade-inc.com)

## **Brigade Electronics (Canada) Limited**

c/o Fluke, 450 Sherman Ave N  
Hamilton, ON L8L 8J6. Canada  
Tel: +1 (604) 245 1752  
Email: [contact@brigade-electronics.ca](mailto:contact@brigade-electronics.ca)  
[www.brigade-electronics.ca](http://www.brigade-electronics.ca)

## **Brigade Electronics (Polska) sp. z o.o.**

ul. Olszewskiego 6,  
25-663 Kielce. Poland  
Tel: +48 887 480 950  
Email: [info@brigade.com.pl](mailto:info@brigade.com.pl)  
[www.brigade.com.pl](http://www.brigade.com.pl)

## **Spain**

[brigade-electronics.es](http://brigade-electronics.es)

 **You're safer with us** 

